

ANNUAL 2021

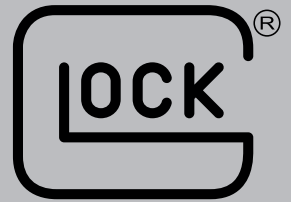

PERFECTION

SAFE. SIMPLE. FAST. = CONFIDENCE.

www.glock.com



Are You Ready For a Better View? **G43X MOS and G48 MOS**

Pages 22-30

#IamGLOCK

- GLOCK Leads The Way
- Testimonials
- The Well Armed Woman
- Shoot Like A Girl
- A Girl & A Gun

New Firearm Owner's Section

- Fundamental Tips
- Finding The Perfect Fit
- Storage Solutions +++



G43X

G48

MOS

Pages 40 & 45
GLOCK TRAINING

Pages 55-79
GLOCK BACKS THE BLUE
Agency Spotlights Across The U.S.A.

HIGH-PERFORMANCE PISTOLS

With the Latest Gen5
Technologies from GLOCK™

At GLOCK, we're continuously evolving our products through future-forward manufacturing and the latest and greatest tech. Get to know our newest advancements in the pursuit of perfection: the Gen5 pistols.



Ambidextrous slide stop levers for increased ergonomics

Firing pin safety

Various Gen5 models are also available in MOS configuration

Flared mag-well for faster, smoother reloads

GLOCK Marksman Barrel for improved accuracy

Front serrations for an additional tactile surface choice

Removal of the grip finger grooves for better fit and comfort

nDLC finish for protection against corrosion and scratching

Trigger spring enhancements and smoother trigger pulls and resets



To see the Gen5 lineup and learn more about each, visit us.glock.com/gen5

CORVUS



PROUDLY MADE IN THE USA SINCE 1969
800-874-2526 galcousa.com f y t i p





NEWS FROM THE WORLD OF GLOCK

- 6** GASTON GLOCK'S ANNUAL LETTER
Gaston Glock
- 7** RAILED & EQUIPPED: NEW GLOCK SLIMLINE MODELS G43X MOS AND G48 MOS
Chris Edwards
- 11** GLOCK'S MODULAR OPTIC SYSTEM: SEE THE DOT, SHOOT THE DOT
Chris Edwards
- 13** EXCEEDING EXPECTATIONS: THE GLOCK 44 .22 LR PISTOL
Chris Anthony
- 16** OUT WITH THE OLD, IN WITH THE NEW: GEN4 VS. GEN5
CWO-5/Gunner Christian P. Wade, USMC (Ret.)
- 20** GENERATION EXPANSION: GLOCK'S .40 AUTOS UPGRADE TO GEN5
Chris Edwards
- 36** TODAY'S FIREARM RETAILER
Mike McAllister



- 22-30** GLOCK LEADS THE WAY
CONFESSIONS OF A NEGLECTFUL OWNER
SURVIVING FIRE
CAN'T SINK A GLOCK
TWO YEARS LOST IN THE MUD
LOST, FOUND, AND GOOD AS NEW
SHOOT LIKE A GIRL
THE WELL ARMED WOMAN
A GIRL & A GUN



GLOCK ON THE RANGE

- 32** BEHIND THE SCENES WITH TEAM GLOCK
Rick Stewart
- 38** GEAR DUMP: GLOCK PROS SHARE THEIR BEST GEAR TIPS FOR DUTY AND COMPETITION
- 40** GLOCK PROFESSIONAL, INC. A PERFECT MATCH TO A WORLD-CLASS GUN
CWO-5/Gunner Christian P. Wade, USMC (Ret.)
- 42** NEW GUN OWNERS FIND FUN, FAMILY, AND COMPETITION WITH GSSF
Meghan R. Lowery
- 44** GLOCK SPORT SHOOTING FOUNDATION 2021 MATCH SCHEDULE
- 45** ESSENTIAL CARRY: THE GLOCK LOW-PROFILE OPERATOR
Chris Edwards

NEW GUN OWNERS

- 46** CALLING ALL NEW FIREARM OWNERS: WE'RE HERE TO SHOW YOU AROUND!
Chris Eger
- 47** PISTOL FUNDAMENTALS: TIPS TO KEEP YOU ON TARGET
Chris Mudgett
- 48** WELCOME, NEW HANDGUN OWNERS!
Massad Ayoob
- 50** FINDING THE PERFECT FIT
Tatiana Whitlock
- 52** SAFE FIREARM STORAGE: EVERY GUN OWNER'S FIRST RESPONSIBILITY
Chris Eger

TIPS, TOOLS, AND FUN FOR ALL

- 84** GLOCKS FOR SOUTHPAWS
Massad Ayoob
- 86** GUIDED BY THE LIGHT: LIGHT AND LASER ACCESSORIES FOR GLOCK PISTOLS
Chris Edwards
- 88** GLOCK 44: A HANDGUN INSTRUCTOR'S BEST FRIEND
Chris Eger
- 89** THE GLOCK COLLECTORS ASSOCIATION: GLOCK FANS JOIN HERE!
Robert A. Sadowski
- 90** 2020 GLOCK ANNUAL SHOOT XXVII & GUNNY CHALLENGE XVI
Andre' M. Dall'au

GLOCKS ON DUTY

LAW ENFORCEMENT SPECIAL SECTION



55 WE HAVE YOUR SIX:
GLOCK'S CONTINUING LAW ENFORCEMENT LEGACY
Mike McAllister

56 ALABAMA'S CALHOUN COUNTY
IS GLOCK COUNTRY
Andre' M. Dall'au

58 SCOTT COUNTY MN SHERIFF'S OFFICE:
A DECADE OF TRUSTING GLOCK
Sean Curtis

61 NEW JERSEY'S EAST BRUNSWICK
POLICE UPGRADE TO GLOCK 45 AND
GLOCK 43X 9X19s
Sean Curtis

64 GLOCK IS THE GO-TO CHOICE
FOR POLICE OF THE LONE STAR STATE
Chris Eger

68 PENNSYLVANIA'S CAPITOL POLICE
SWITCH TO GLOCK
Sean Curtis

70 U.S. CUSTOMS AND BORDER PROTECTION
FIELDS GLOCK TO PROTECT HOMELAND
Chris Eger

72 THE GLOCK 45s OF TAMPA BAY
Andre' M. Dall'au

76 GEORGIA'S SANDY SPRINGS P.D. ADOPTS
THE GLOCK 45 MOS
Sean Curtis

78 GLOCK: TURNING SKEPTICS
INTO BELIEVERS
Sean Curtis



PG. **11** GLOCK'S MODULAR
OPTIC SYSTEM:
SEE THE DOT, SHOOT THE DOT



PG. **32** BEHIND THE SCENES
WITH TEAM GLOCK

GLOBALLY GLOCK

GLOCK in Service Around the World

74 SECURING THE WORLD
Chris Eger

80 PORTUGUESE ARMY CHOOSES
G17 GEN5 AS NEW SERVICE ARM
Bryan Ferreira

81 PROTECTING FRANCE: THE
REPUBLIC ADOPTS GLOCK
Chris Eger

82 SAVE A RHINO, SAVE A LIFE
Terrick Naude, GLOCK
South Africa



PG. **48** WELCOME, NEW
HANDGUN OWNERS!



PG. **68** PENNSYLVANIA'S CAPITOL POLICE
SWITCH TO GLOCK

GLOCK ANNUAL is published annually by BANG Media, LLC, P.O. Box 385, Marco Island, FL 34145.

Single copy price: \$10.00 U.S.A., \$12.00 in Canada + S&H. Submissions must be accompanied by a stamped, self-addressed envelope. The publisher assumes no responsibility for unsolicited material. Copyright © 2021 by BANG Media, LLC. All rights reserved under International and Pan American Copyright Conventions. Reproduction in whole or part without written permission of the publisher is strictly prohibited. Printed in the U.S.A.

To the readers: Be advised that there may be products represented in this magazine as to which the sale, possession or interstate transportation thereof may be restricted, prohibited, or subject to special licensing requirements. Prospective purchasers should consult the local law enforcement authorities in their area. All of the information in this magazine is based upon the personal experience of individuals who may be using specific tools, products, equipment, and components under particular conditions and circumstances, some or all of which may not be reported in the particular article and which this magazine has not otherwise verified. Nothing herein is intended to constitute a manual for the use of any product or the carrying out of any procedure or process. This magazine and its officers and employees accept no responsibility for any liability or damages arising out of any person's attempt to rely upon any information contained herein. The opinions expressed in the enclosed articles are not necessarily those of GLOCK, Inc.

BANG MEDIA

HIGH VELOCITY MARKETING

Shirley Steffen, Publisher
Karin Levine, Advertising Director
Brandie Collins, Technical Editor

BANG Media, LLC
P.O. Box 385, Marco Island, FL 34145
bangmediamarketing.com



Eggenberger Photo

ANNUAL MESSAGE FROM THE FOUNDER

It gives my wife, Kathrin, and I great pleasure to welcome you, our devoted fans, to another edition of the *GLOCK Annual* magazine. This year, GLOCK celebrates its 35th year in the United States, and we would not be where we are today without all of you. Each year we establish new milestones to reach, and each year, with your dedication, we not only achieve these goals, but we make history. This year is no different.

The past year has presented many challenges from a global pandemic to social unrest, which has impacted everybody around the world in many different ways. Our number one priority has been for the safety of our staff and the GLOCK community and we have established new guidelines and protocols to ensure an optimal work environment. This has enabled us to continue to meet the demands of our customers.

We have also implemented a new program for energy conservation and environmental friendliness that has increased our recycling efforts and maximized energy reduction across the factories. We have made all of our employees aware of our initiatives to go green and to protect our planet. We are trying very hard to do our part in the world.

With that, we have been able to stay open and stand out above, which has led us to historical record sales going into 2021. We have had a record number of purchases from first-time buyers and met the requirements and were selected by the United States Coast Guard as their new service pistol. In 2020, we reached over 20 million handguns sold globally. GLOCK continues to perform at the highest levels to deliver the world's most reliable pistol.

I am also pleased to announce that in 2021, the GLOCK Sport Shooting Foundation will celebrate its 30th year in the United States. This year we will add the MOS Stock Division to the matches to allow more types of shooting along with the recently added rimfire division. With the increase of first-time buyers and the growth in GSSF members, we are now allowing qualified persons who are not law enforcement to take the following GLOCK training courses: Brilliance in the Basic, Operator, MOS Operator, and Low-Profile Operator.

In this year's *Annual*, you will find articles by some of our greatest admirers talking about GLOCK pistols and their capabilities. Reports range from the recently introduced Slimline optic-ready pistols to our new Gen5 .40-caliber pistols, new training opportunities, and first-time buyer information. I know you will enjoy reading them as much as I have.

At this point we would like to say "thank you" to you, our customers and fans. You put your faith and your trust in our products every day, and we are grateful for that. As we start the New Year and go about our daily life, I ask that you also remember where we started and where we are going. We are each powerful. Together we are strong. The future is GLOCK Strong.

Sincerely,

A handwritten signature in black ink, appearing to read "Gaston Glock".

Gaston Glock,
Founder



GLOCK ensures people have the most advanced carry guns they can buy in the new Slimline G43X MOS and G48 MOS. The pair feature GLOCK's Modular Optic System (MOS) that accommodates more red-dot sight brands and numerous models.

RAILED AND EQUIPPED: NEW GLOCK SLIMLINE MODELS G43X MOS AND G48 MOS

SLIM AND SLEEK, THEIR DEBUT AS CARRY GUNS GAINED INSTANT ACCLAIM.
TWO NEW FEATURES ELEVATE THEIR GAME IN 2021.

■ ARTICLE BY CHRIS EDWARDS

When the world becomes more complex and concerning, humans seek simplification and order. Living through some of the most challenging times in recent history that humans have encountered, there are a few things we know we can rely on to deal with a crisis. While hopefully never deployed in a true emergency, a GLOCK pistol meets the criteria for lifesaving equipment. After all, if one needs a personal firearm, one could do no better than the GLOCK brand.

Over the last several decades, GLOCK pistols have become the standard by which all others are measured. Safe, reliable, and

simple to use, it is no coincidence that all kinds of people—from defenders of country and order to individuals determined to be responsible for themselves and their loved ones—choose GLOCK to be at their side.

Beginning with the GLOCK 17, the brand has expanded and evolved according to demand and technological developments. From the beginning, Gaston Glock followed a set of principles that directed him and his company to produce, distribute, and support the now-iconic pistol line. Much has changed since the early 1980s, but the critical requirements of a mechanism remain the same.



The small footprints of the G43X MOS and G48 MOS models make them ideal carry guns for active people who know that ounces count when they're off the beaten trail.



A GLOCK mounting rail system allows users to add a variety of firearm-mounted lights and lasers, tools that are trending with concealed-carry and home-defense practitioners.

A PROGRESSIVE EVOLUTION

We come at this point to the models G43X and G48. Slim and sleek, they embody the elements essential to a defensive device.

Reliability, as postulated by the renowned firearm instructor Jeff Cooper, is the first of those elements. A lifesaving device must work, at least as far as human ingenuity can accomplish that. GLOCK pistols have long set records for reliability. At times, the test personnel have quit after thousands and thousands of rounds were fired and no stoppages occurred. Indeed, the G43X and G48 embody the same performance attributes as their larger relatives.

Safety and ease of use have been mainstays of GLOCK pistols since the design and introduction of the “Pistole 80” (G17) in the 1980s. Those qualities have been maintained through the generations and will continue to be, as they are a guiding principle of Mr. Glock’s. His SAFE ACTION® fire-control system has stood the tests of time and worldwide use, and it is incorporated in the Gen5 technology inherent to the G43X and G48 Slimline MOS models.

With the major metal components of each GLOCK bearing a super-hard surface finish and the GLOCK Marksman Barrel (GMB) in both new Slimline models, the qualities of durability and accuracy are on par with all other GLOCKS.

The surface finish requires minimal maintenance; while this lends to some saying you can treat your GLOCK “like your lawnmower,” that is not advocated. Still, GLOCKS need minimal care. As an instructor and daily carrier, I inspect and maintain GLOCKS regularly and teach others to do the same. Without such maintenance, though, it is comforting to know that these pistols can take more than anything to which I could ever reasonably subject them.

As far as accuracy is concerned, the G43X and G48, with quality ammunition, will shoot more accurately than almost any operator is capable of in realistic conditions. I would have no hesitation engaging a practical target out to 50-plus yards with the expectation of success—and with the addition of an electro-optical sight, that just got easier.

A RED-DOT SIGHT DOESN'T MISS

Introducing a red-dot optic and an accessory rail causes the G43X and G48 in their MOS versions to claim their places as critical accessories for the independent lifestyle.

The new GLOCK Slimline G43X and G48 come equipped with an MOS—modular optic system—slide cut. These slots are designed for mounting compact red-dot optics while eliminating the need for separate mounting plates to accommodate various sight brands.

That design also means the body of the optical sight is that much closer to the shooter’s actual line of sight, which accomplishes two things. First, there is no need for higher, suppressor-type back-up sights. The standard GLOCK sights are visible through the lens of whatever compact red-dot you choose to mount. Second, the dot is easier and quicker for the eyes to pick up, something I noticed against almost any background.

A side note here regarding the efficiency of these kinds of sighting systems: Compact red-dot optics and reflex sights are compatible with the natural tendency of an operator to look at the *target*—and that’s easier than trying to line up a front sight with a rear sight and focusing on the front sight. With a red-dot, the shooter looks at the desired impact zone and brings the gun and optic up to the sight line. Assuming the sight has been zeroed correctly, the dot will cover where the projectile will impact.

“With a red-dot sight, increased situational awareness is afforded by having both eyes open naturally. The field of view is almost doubled compared to using iron sights.”



There is also the advantage of increased situational awareness afforded by having both eyes open naturally. With a red-dot sight, the field of view is almost doubled compared to when using iron sights. Another benefit shines in the ease of instruction and training with a red-dot sight-equipped GLOCK. GLOCK's Director of Training, J. "Willie" Parent, described a recent session in which he took a new shooter to the range who had almost no experience with handguns. Utilizing a GLOCK equipped with a red-dot sight, the new shooter was quickly able to score hits on a practical-sized target—and past 50 yards! The credit for such fast acclimation is owed to the elimination of having to shift one's natural focus from the target to iron sights. Put the dot where you want the bullet to go and pull the trigger. Speed and accuracy are realized in a much shorter time frame.

Today's red-dot optics are quite advanced compared to those of just a generation or two ago. For instance, many units now incorporate an auto-adjustable dot-intensity feature. This means the dot brightens or dims according to the ambient

light. Bright sunlight, brighter dot. Subdued or low light, the brightness decreases so as not to overwhelm vision. You likely won't find yourself changing the batteries very often, either. Estimated dot life is over two years when this auto-adjust feature is present.

A RAIL FOR DIRECTED ENERGIES

The other new addition to the G43X and G48 Slimline MOS models is a GLOCK mounting rail system for accessories. This gives these Slimlines the same advanced capabilities of their larger relations.

A light source attached to a firearm is recognized as one of the speediest and most efficient ways to illuminate a target. The light is aligned with the firearm's bore, its positioning in front of the trigger guard allows the operator to utilize a two-handed grip, and mounted lights can be turned on and off with the shooting hand. A hand-held light is always advocated for utility purposes, but nothing beats the mounted unit when



Those who prefer a GLOCK Slimline for concealed carry have two premium tools at their disposal with the new G43X MOS and G48 MOS. Both are in 9x19, sport GLOCK's Modular Optic System, and have GLOCK's mounting rail system for on-board lights or lasers.

it comes to engaging deadly targets, as special operations military personnel and U.S. law enforcement have realized countless times.

The unit illustrated in the picture on page 8 is from SureFire, a longstanding manufacturer of durable and high-performance light products. This light further miniaturizes the firearm-mounted light, and it's rechargeable. It is a certainty that other manufacturers will adapt quickly to the GLOCK G43X MOS and G48 MOS models, and consumers should have numerous choices in the near future.

THESE GLOCKS CHECK ALL THE BOXES

A minimalist and superb tool for self-defense, the G43X and G48 MOS models encompass several critical attributes:

- They are chambered in 9x19, a caliber readily available in the U.S., with numerous loadings for training, competition, and defense against all sorts of threats.
- They provide the ability to mount an electro-optical sight, resulting in improved performance by the trained operator.
- They incorporate a system for attaching lights or other sighting devices, elevating the Slimlines to "extreme-duty" status.
- All the familiar and superb GLOCK pistol qualities are here. These pistols are safe, durable, reliable, and distinctly accurate, and they incorporate both GLOCK's renowned hard-surface finish and its GMB barrel.

RANGE CONFIRMATION

I had the privilege of shooting one of the first G43X MOS models available. The G43X is my personal preference, though many serious shooters such as Scotty Banks, GLOCK's Training Manager, work with the G48 for its balance and slightly longer sight radius. I found that, with the MOS versions and a



No matter the chore, no matter the elements, the Slimline G43X MOS and G48 MOS models are just as tough as every other GLOCK ever made. Don't leave home without one!

mounted red-dot sight, sight radius became inconsequential. At the same time, having spent a good deal of time shooting the smaller G43 beforehand probably influenced my choice; the G43X MOS "feels" better to me, and that's why I chose it for a range evaluation.

My testing included a run of the GLOCK Operator Course "Standards." This is a comprehensive test of practically all skills a shooter might conceivably need in an emergency. Multiple draws from a holster, reloading, shooting with both and each hand, and shooting while on the move are included. After just a few shots to confirm zero of the optical sight, I performed a scored run—and my reward was a clean, no-misses run on the official targets in a very respectable time. And with that, another GLOCK needed to be added to my collection! I wasn't alone. Several GLOCK instructors handling their first examples of the G43X MOS came to the same conclusion.

For those shooters who prefer a slightly different balance, the G48 MOS, as I said, offers a longer barrel and slide. The magazine capacity remains the same at 10 rounds. Either gun, either choice, the G43X MOS and G48 MOS are made for success. ☺

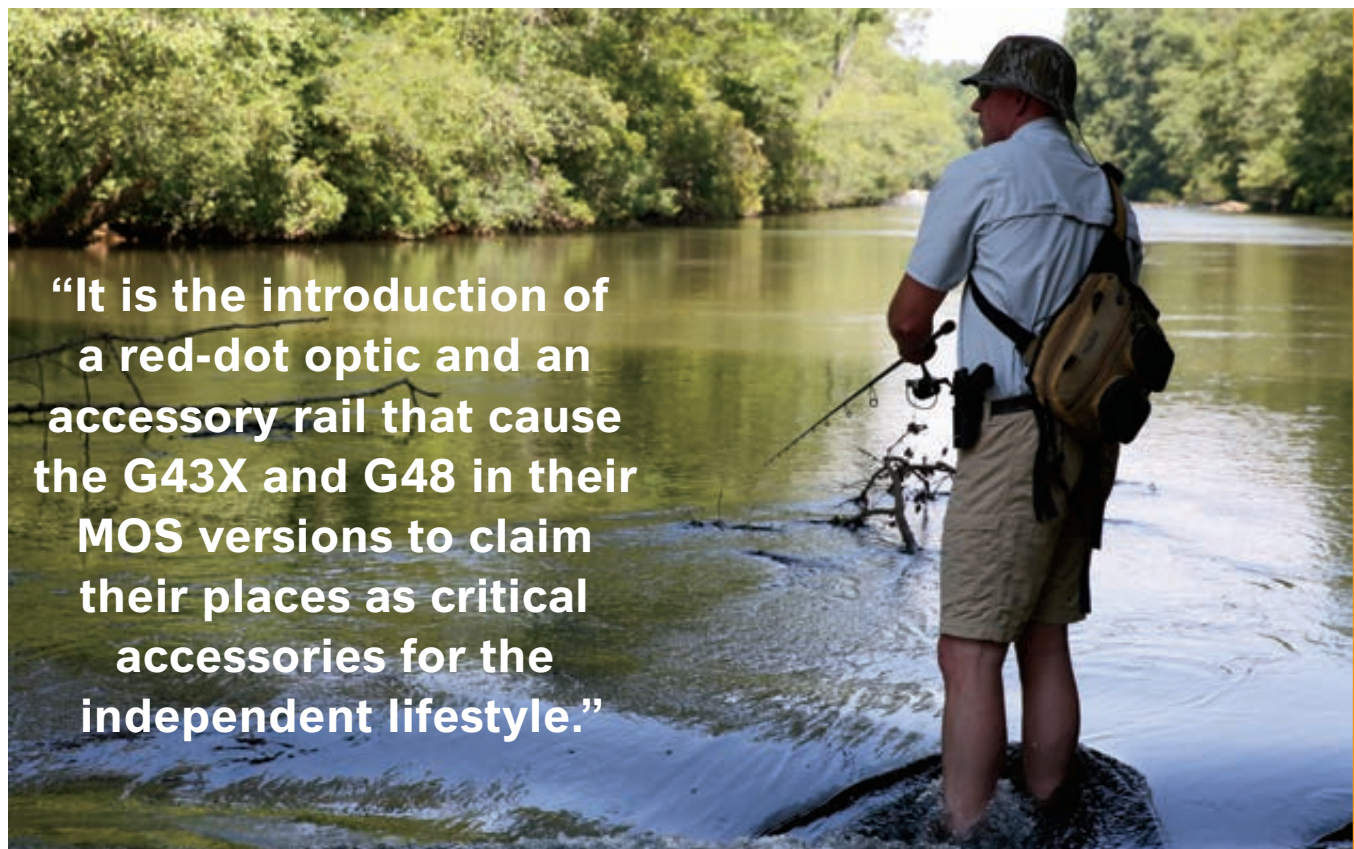

"It is the introduction of a red-dot optic and an accessory rail that cause the G43X and G48 in their MOS versions to claim their places as critical accessories for the independent lifestyle."

GLOCK'S MODULAR OPTIC SYSTEM: SEE THE DOT, SHOOT THE DOT

RED-DOT OPTICS HAVE UPPED THE ACCURACY QUOTIENT FOR THOUSANDS OF SHOOTERS. GLOCK MODELS WITH THE MODULAR OPTICS SYSTEM SIMPLIFY ADDING ONE OF THESE HANDY TOOLS AND IMPROVING YOUR GAME.

■ ARTICLE BY CHRIS EDWARDS

The use of electro-optic sights, or “red-dot sights,” as they are commonly referred to, has become mainstream in the world of handgun shooting across the spectrum of law enforcement use, home- and self-defense practitioners, and competitors everywhere. Their original configurations were much like a standard scope, tubular in form, but perched atop the slide via awkward mounting frames that were, in most cases, attached by screwing them into the gun’s frame. Changing red-dot optics then was neither fast nor convenient. While they presented distinct advantages over iron sights, they were bulky and often adversely affected the overall balance of the gun. Today’s red-dot sights for handguns, now seen almost exclusively in a single-lens “reflex” design, are galaxies away from those first tools. They are tiny—many weigh just a few ounces—and they now mount directly on the slide via a machined cut.

With the arrival of these miniature sights, it seems that advances in red-dot sight technology had reached a zenith. But, there was one problem: Across the many makers of red-dot optics, there was no universal mounting design. Each brand

“It has been an unprecedented hit, especially with law enforcement agencies looking for technology to keep one step ahead of the world’s criminal element.”



required a different slide cut for mounting. That, as you might expect, posed a problem if a person wanted or needed to switch to a different sight.

It was GLOCK that came to the rescue of this dilemma with its Modular Optic System (MOS). The GLOCK MOS is a set of attachable/detachable plates, each plate accommodating a sight or sights from a range of optics manufacturers. Want to upgrade to the newest red-dot optic on the market? GLOCK has a mounting plate for that.



In creating a mounting solution for red-dot sights that accommodates numerous sight models from different manufacturers, GLOCK solved a problem no other handgun maker has been able to.

Need to replace a red-dot that's come to the end of its life? That's no problem either.

The MOS system was introduced with GLOCK Gen4 pistols and continues with Gen5 GLOCKS. It has been an unprecedented hit, especially with law enforcement agencies looking for technology to keep one step ahead of the world's criminal element. A testament to that fact is that a recent procurement contract from the largest American federal law enforcement agency dictated that service pistols be optic-ready. After extensive competitive testing, GLOCK MOS models will serve as the next service pistols for the U.S. Customs and

Border Protection. Additionally, there is a surge of interest in the commercial market, not only in competition arenas, but for personal-defense use as well.

The benefits of red-dot sights are well known and should be explored by operators of all stripes. Millions have come to realize that, after training, it's as simple as "see the dot, shoot the dot," and a GLOCK MOS is a natural solution to capitalizing on the technology today's red-dot optics makers have perfected. A number of reputable manufacturers make sights that are compatible with GLOCK MOS handguns. Try one the next time you head to the range. You'll be glad you did. ☉



SYNTHETIC CLP & Bio-CLP Gun Oil



G96 is the only gun care company approved by the U.S. Army, law enforcement agencies, and armed forces all over the world since 2009.

G96 SYNTHETIC CLP & BIO-CLP GUN OIL is formulated for maximum gun and environmental protection. Significantly improves clean up after firing. Safe for use on polymer weapons.

- CLEANER • LUBRICANT
- PRESERVATIVE



Available sizes:
0.5 fl. oz.
4 fl. oz.
1 pint
1 liter
1 gallon
55 gallon drums

G96 PRODUCTS INC.

85-5th AVE., BLDG. #6, PATERSON, NJ 07524 • Tel: 973.684.4050 • Fax: 973.684.3848
E-mail: info@g96.com • Website: www.g96.com



GLOCK engineers set out to design a .22 LR pistol that functioned every time the trigger was pulled and was as durable as its larger-cartridge brethren. They did not disappoint with the G44.

EXCEEDING EXPECTATIONS: THE GLOCK 44 .22 LR PISTOL

IT TOOK GLOCK MORE THAN A DECADE TO CREATE A RIMFIRE PISTOL THAT LIVED UP TO THE REPUTATION OF THE GLOCKS THAT CAME BEFORE IT. YOU KNOW WHAT THEY SAY: GOOD THINGS COME TO THOSE WHO WAIT.

■ ARTICLE BY CHRIS ANTHONY

GLOCK dominates the 9x19 handgun world, with its long tradition of reliability, manufacturing excellence, and battle-tested functionality. The legendary GLOCK 19 and GLOCK 17 have become the standard by which most striker-fired handguns are designed. When you ask most shooters, everything else in the 9x19 world seems to compare to a G19 or G17.

GLOCK applied the same acumen to the .40 AUTO, .45 AUTO, and .380 AUTO platforms with the GLOCK 22, GLOCK 21, and GLOCK 42. But what about the ever-popular .22 LR?

It was a question shooters had been asking for years. From recreational target shooters—“plinkers”—and beginners to those who wanted a cost-efficient way to train, the bantam-weight .22 LR has always been a popular chambering.

GLOCK heard the question and, after years of design work, engineering, and testing, released to the shooting world its first .22 LR handgun—the GLOCK 44—just before the start of 2020. It did not disappoint.

OVERCOMING THE .22 LR CHALLENGE

For the engineers at GLOCK, building a .22 LR handgun was never going to be about compromise. With the GLOCK name comes a steadfast adherence to quality, functionality, and reliability: When you pull the trigger, the handgun operates properly every time, no ifs, ands, or buts.

Some manufacturers have looked at designing a .22 LR version of their firearm as more of a “range toy”—one that’s okay if there’s a hiccup in its functionality from time to time. That perspective makes some sense, since .22 LR ammo can take its toll on a handgun. Dirty, inconsistently manufactured rounds play havoc with most striker-fired designs. Add to that the complexity of getting a slide to cycle consistently because of the round’s low recoil, not to mention the cartridge’s profile, which can be problematic in magazine feeding and chambering, and it all adds up to a detailed equation that’s hard to get right.

GLOCK met the challenge head on, and, in the end, the G44 set the standard for others in the industry to create a handgun that matches its 9x19 brethren in both form and function.

“After years of design work, engineering, and testing, GLOCK released its first .22 LR handgun—the GLOCK 44—just before the start of 2020. It did not disappoint.”

The journey began in 2008, with GLOCK product managers recognizing the demand for a .22 LR handgun. But with a company focused primarily on creating products for law enforcement and military bodies, it took nearly a decade before the first working prototype debuted in 2017.

“Most of the changes to the prototype were to small parts, so the next version was installed and tested in the same configuration as the previous part,” GLOCK says. “This allowed for true monitoring to see if a new part was superior to its predecessor.”

And after three years of refining and testing, GLOCK delivered its .22 LR G44 to an eager market.

UNLIKE ANY OTHER

So, what is it that makes the G44 so special? Most obvious, the G44 carries almost the same dimensions as the legendary G19, almost certainly the most popular handgun on the planet. More importantly, the G44 is a purpose-built handgun, not a conversion kit or a scaled-down analog.



Interchangeable backstraps, a reversible magazine catch, an adjustable rear sight, and a 10-round magazine that includes a load-assist lever help make the G44 a pleasure to shoot.

Have a G19 holster and mag carriers? The G44 rig will fit like a glove, no need to build out a second set of range gear. That's particularly important when it comes to new shooters entering the market or thinking about it. The G44 is the perfect setup to help novices gain confidence with a low-recoil, low-weight version of their defensive purchase—same grip, same sight radius, same draw.

Aside from the form factor, the G44 boasts some revolutionary design elements that have eluded others in the industry for years. For one, the G44 is built with a hybrid



The G44 is an excellent training pistol, as it closely mimics the feel of a G19 9x19, but with less weight and recoil. Both new shooters acclimating to a first handgun and experienced shooters alike appreciate these features.



Many manufacturers scale down their full-size pistols or opt to make a conversion kit when offering a .22 LR. Not GLOCK. The G44 is a purpose-built rimfire handgun meant to function flawlessly.

steel-polymer slide; the primarily polymer slide is bonded to a steel skeleton that forms the rails for the grip module. This design created a slide weight that functions properly with a wide range of .22 LR ammunition, while still retaining the durability expected of any handgun that carries the GLOCK name.

Under the slide, the G44 fires from a 4.02-inch GLOCK Marksman Barrel (GMB) that features polygonal rifling and an enhanced crown. The beauty of that barrel is more than skin deep. The G44's barrel locks to the slide rather than being fixed to the frame as with other .22 LR pistols, making the handgun function more like its heavier brethren. For shooters who like to run a suppressor on a .22 LR (and who doesn't?), GLOCK also offers a threaded barrel.

The G44 also features an ambidextrous slide-stop lever, reversible magazine catch, an adjustable rear sight, and interchangeable backstraps to match any shooter's preference for fit, feel, and control.

Each G44 comes with two 10-round magazines that include a load-assist lever that helps shove those pesky .22 LR rounds into place. There has been some discussion about the magazine's round count; at just 10, the training capabilities of the G44 might be a bit handicapped.

HEAD-TO-HEAD

Okay, enough already. What's it like to shoot? Well, how does any GLOCK shoot?

There are plenty of write-ups out there that deliver the tester's impressions of the shooting the G44—and all of them are remarkably consistent in their enthusiasm for the handgun's ease of use, ergonomics, and reliability.

Taking it to the next level, how does it stack up against, say, the G19? Does the G44 deliver the same functionality, fit, and accuracy but in a smaller caliber and lighter package?

During a recent test shoot with friends, we ran a standard IDPA 5x5 classifier with both the G19 and the G44. The same holsters, magazine carriers, belts, and marksmanship

The GLOCK Marksman Barrel is just one way designers ensured the G44 would be as accurate as any other GLOCK.



standards were used across the board, so while it wasn't a perfect apples-to-apples evaluation, it was pretty darned close.

The results? Even with lighter recoil, a significant weight difference (the G44 is much lighter than the G19), and a mix of different .22 LR ammunition, the scores with the G44 compared to the G19 scores were incredibly similar. There was no appreciable difference in draw feel or speed, no significant difference in reload times (the G44 magazine dimensions are very close to the G19's), and the stock sights were one-to-one on target.

Conclusion: No learning curve. No gear changes. No modifications of basic shooting techniques.

Overall, the G44 is a handgun that certainly checks the boxes for novice shooters. At the same time, it's every bit as attractive to advanced marksmen and those who carry on the job looking for a low-cost, low-impact training option to keep skills sharp. Taking those two views as a whole, it's clear that GLOCK accepted the challenge to build a .22 LR handgun that lived up to its reputation for form, function, and reliability. Fortunately, with the G44, the shooting world got that and a whole lot more. ☺

OUT WITH THE OLD, IN WITH THE NEW: GEN4 VS. GEN5

GLOCK'S GEN5 PISTOLS EXCEED THE REQUIREMENTS FOR RELIABILITY AND DURABILITY—INDEED, PERFECTION—IN EVER GREATER EXTREMES.

■ ARTICLE BY CWO-5/GUNNER CHRISTIAN P. WADE, USMC (RET.)



GLOCK Perfection. Volumes of operational test data and operator input have manifested in the most capable GLOCK generation ever—the Gen5 series.

With each successive generation of GLOCK SAFE ACTION® pistols, I find myself enjoying increasing capability levels. Just when I think GLOCK engineers could achieve no greater efficiency, each subsequent generation presents me new potential heretofore unimagined.

When GLOCK introduced its Gen5 series, I immediately took notice because the Gen5, under another name, was the choice of the FBI's after undergoing the agency's thorough and credible service-pistol contract process. The winners of that demanding selection process were the GLOCK 17M and GLOCK 19M—the genesis models of the GLOCK Gen5 series. While I am always interested in purchasing more GLOCK pistols for my collection, I was most interested in determining whether a Gen5 pistol offered attributes I didn't yet have in my primary defensive handgun, a GLOCK 19 Gen4 9x19.

A DETAILED STUDY—AND IMPULSIVE PURCHASE

The first question I pondered was, "If the GLOCK Gen5 is good enough for FBI agents, does that automatically mean the GLOCK Gen5 is good enough for me?" Given that many of us do not enjoy an externally provided budget for new-gun testing, my next question was, "Are the improvements in the GLOCK Gen5 worth an additional expenditure?"

As I began my research on the GLOCK Gen5 pistols, those questions grew to a great many more. I read and studied as much information as I could find about Gen5s, and as soon as possible, I found a GLOCK 17 Gen5 in a nearby shop for close inspection.

"The proof of the pudding is in the eating," as they say, and during the initial physical inspection of the pistol in that gun store, I found GLOCK had introduced far more engineering refinements to its Gen5 series than I'd anticipated. The first advancements I noted were the improved GLOCK Marksman Barrel, smoothed and blended frame and slide edges, an ambidextrous slide-stop lever, removal of finger grooves, a fully beveled magazine well, and a new nDLC finish. After

“During the initial inspection of the pistol in that gun store, I found GLOCK had introduced far more refinements to its Gen5 series than I’d anticipated. I admit it, I purchased it right then and there.”



GLOCK Gen5s retain the simplicity and all the best engineering qualities of previous generations, while introducing performance-enhancing capabilities all operators will appreciate.



GLOCK Gen5 pistols feature improved ambidextrous controls for left-handed shooters and non-dominant-side operation.

properly clearing the pistol and admiring the new, high-visibility magazine follower, I went straight for what I believe to be one of the most essential character traits of a pistol, the trigger “feel.” I had read that GLOCK had incorporated new trigger enhancements with the Gen5 series, and upon repeated dry-practice iterations, I was impressed at the upgraded crispness, clean break, and rapid reset.

Next, I disassembled the new G17 Gen5 for detailed inspection. I immediately found a more robust and precise firing pin safety engagement, the omission of the locking block pin, and a new trigger spring design, no doubt the face behind the improved trigger feel. I was also encouraged by the redesigned ambidextrous slide-stop lever with a coil spring in place of a leaf spring, as well as a strengthened trigger bar.

I admit it—I purchased the G17 Gen5 right then and there. Impulsive that may have been, but I was committed to discovering whether my new pistol would force my G19 Gen4 into an early, albeit respectful, retirement. It was time to put the G17 Gen5 to the test, empirically and anecdotally.

I use the word “anecdotally” very carefully, in the sense that I am searching for the answer to the question, “After all the empirical evidence analysis is complete, will I feel more confident with a GLOCK Gen5 or the GLOCK Gen4?” Having engaged in close combat with enemy forces over six combat deployments, I place a premium on the partially subjective and abstract concept of confidence and complete trust in one’s firearm. I continue to seek a pistol that inspires such confidence since, despite having retired from fighting on the world’s battlefields, I have returned home to be in the frequent presence of grizzly bear, black bear, and the gray wolf in the mountains of Montana. These dangers continue to drive my requirements.

RANGE TIME—AND ANOTHER PURCHASE

The next logical step in the discovery process was to head to the range for testing and evaluation. GLOCK Gen5 pistols retain the multiple interchangeable backstraps and the reversible magazine catch of the previous generation. I quickly

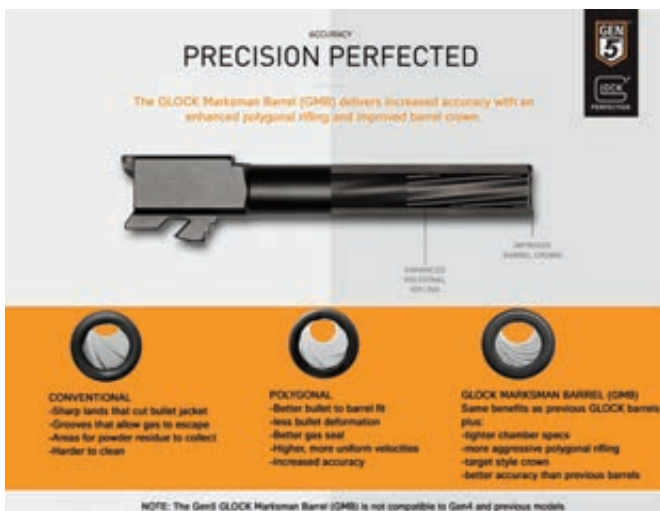

installed the medium beavertail backstrap. Despite the Gen5's omission of finger grooves, and given my relatively large hand size, I perceived a counterintuitive and unexpected increase in grip purchase. The GLOCK Gen5's frame easily shrugs off even my most enthusiastic attempts at a crushing grip, greatly contributing to my ability to maintain the pistol on target for rapid and accurate subsequent shots. Also, I am right-handed and initially somewhat indifferent to the addition of the ambidextrous slide-stop lever. But, once I began conducting

weak-side and left-handed-only training drills, I quickly appreciated this new functionality. The fully beveled magazine well allowed me to reload more quickly, aggressively, and consistently.

During intermittent range inspections, I was pleased to discover that GLOCK had found a way to make the Gen5 pistol easier to disassemble and reassemble due to refinements in the trigger and locking-block components. While I was not expecting this, I welcomed it.

I began to conduct repeated immediate-threat engagement drills, multiple-threat engagement drills, and speed reloads measured with a timer, and I diligently recorded the results. After gathering sufficient speed and accuracy data with the G17 Gen5, I compared my results against previous data compiled over my years using a G19 Gen4. I could not measure relative reliability data, since I experienced no stoppages in the operation of either generation GLOCK pistol. I imagine such analysis would require a test facility, technicians, and significant amounts of ammunition and time to determine potential differences in reliability for these legendary pistols.

I did perceive a slight advantage in maintaining acceptable physiologically based accuracy with advantage to the G17 Gen5. To determine the exact cause of this measured and perceived differences, I had no choice (at least that's what I told myself) but to head back to the firearm shop and purchase a G19 Gen5; I respectfully ask our readers here to remember that as demanding as we are on ourselves and each other regarding firearm discipline, safety, speed, and accuracy, we are still allowed to enjoy the experience and have some fun.

I promptly brought the G19 Gen5 to the range and began the rigorous and enjoyable data-gathering experience. At the end of it all, I determined that, given the size of my hands, I am faster, more aggressive, and more accurate with a G17 Gen5 due to its larger grip size. Am I physically faster and more accurate with a Gen5 versus a Gen4? Generally, no, but under specific circumstances and due to additional Gen5 features? Yes. Am I more confident with a GLOCK Gen5 pistol?

Absolutely, yes. Data sets from the weak-side and left-hand-only drills revealed advantages from the Gen5's ambidextrous slide-stop lever on both the G17 and the G19 models. I could also clearly see efficiencies gained during speed reloading of the Gen5 pistols, due to the fully beveled magazine well.

As a result of these lessons learned, I decided to retain both the G17 and G19 Gen5s, with favored consideration for my advantages with the G17, since both pistols are engineered for different requirements (concealability, portability, clothing worn, etc.).

NEW POTENTIAL REALIZED

Remember what I wrote in the beginning about "new potential?" Enter the GLOCK Gen5 Modular Optic System (MOS). This feature has facilitated perhaps the most significant enhancement to my overall shooting capabilities since I purchased my first GLOCK handgun 30 years ago. As I age, my eyes continue to lose youthful clarity, suffering to the point where I would need trifocal prescription glasses to properly focus on a front sight and everything else near and far (and never mind if my glasses were to be knocked from my face). All this, of course, assumes the front sight is the thing on which we should be focused while engaged in a defensive encounter with a moving and thinking threat.

Over the past two years, and out of necessity, I have moved to the GLOCK 17 Gen5 MOS, and with dedicated and proper training and education, my general pistol capabilities have transcended the apex of my skill set when my eyes were young and sharp. Installation of a high-quality reflex sight on the G17



The full-size GLOCK 22 Gen5 .40 AUTO is available in both standard and MOS variants.

GENERATION EXPANSION: GLOCK'S .40 AUTOS UPGRADE TO GEN5

FOR THOSE WHO LOVE THE .40 AUTO ROUND AND
HAVE WISHED FOR ALL THE GEN5 TECHNOLOGY AND INNOVATION,
THE WAIT IS OVER.

■ BY CHRIS EDWARDS

The world turned, several years ago, as United States federal law enforcement began to ask for, and later adopt, GLOCK pistols in 9x19. There were many factors driving the change, not the least of which was because testers at government ballistics labs had learned that new technology in defensive 9x19 ammunition had resulted in enhanced terminal performance. Other advantages in adopting GLOCK 9x19 handguns included improved operator success during training, higher magazine capacities, and decreased preventative maintenance over the life of the firearm. State and local agencies also took note, and soon the number of Gen5 9x19 GLOCKS in service was astronomical.

“GLOCK increased the mass of the slide and made adjustments to the recoil spring. The result? A .40 AUTO GLOCK that approaches the shootability of a 9x19.”

Still, some agencies and individuals wished to stick with—or, as it was with one major overseas agency, adopt—.40 AUTO GLOCK pistols, and followers of this popular cartridge were not to be left out when it came to the many advances seen in GLOCK's Gen5 technologies.

GLOCK has done extensive engineering and testing across calibers in the development of its fifth-generation handguns. Today, after testing to meet the exceptional rigors of military use, GLOCK has now introduced the .40 AUTO platform to the family of Gen5 models. The Gen5 GLOCK 35 MOS (Modular Optic System), GLOCK 22, GLOCK 22 MOS, GLOCK 23, and GLOCK 23 MOS, as well as the subcompact GLOCK 27, have all the qualities of other GLOCK Gen5s:

- The extremely durable, rust-resistant, and low-visibility GLOCK nDLC hard-surface finish
- The ambidextrous slide-stop lever
- Reversible magazine catch
- The GLOCK Multiple Back Strap System
- A textured grip surface with full wrap-around coverage
- The precision GLOCK Marksman Barrel
- GLOCK's SAFE ACTION® fire-control system and improved trigger pull
- A flared magazine well for increased ease and speed of loading

Several GLOCK Professional instructors, including some who had carried earlier generations of .40 AUTO GLOCKS in harm's way, were asked to shoot and evaluate the new pistols' characteristics. To a man, they were impressed with the control and reduction in felt recoil and muzzle rise.

To what can that be attributed? Working from the data gleaned from literally hundreds of thousands of rounds fired, GLOCK increased the mass of the slide and made adjustments to the recoil spring. The result is a .40 AUTO GLOCK that approaches the shootability of a 9x19. Indeed, the Gen5 .40 AUTO models look a good deal like their smaller-caliber brethren, only with the slide a bit larger in reflecting its extra mass.

Why push the technology on GLOCK's .40 AUTOS to Gen5 level? Some shooters simply prefer the caliber. Others with field and hunting experience have noted that the .40 AUTO in full metal jacket configuration may penetrate deeper through the heavy bone of four-legged predators. One foreign national police force, lacking ready access to expanding projectiles, picked the .40 GLOCK assumedly for the same reason, but not before that agency conducted an exhaustive, 10,000-round endurance test without incident.

From law-enforcement to military use, competitor, self-defense, and even hunting, the .40 AUTO is one for which many have a sweet spot. For those who have wished for the most advanced GLOCK to go with that favored round, your patience has been rewarded: The wait is over. ☉



GLOCK's Modular Optic System is available on the G22 Gen5 (above), G23 Gen5 (below), and the new G35 Gen5 full-size model.



No matter which .40 AUTO Gen5 GLOCK you choose, you get the GLOCK Marksman Barrel, a textured grip without finger grooves, and a reversible magazine catch.



Imagine the Possibilities

The GLOCK Designer Experience

Over the past year, GLOCK has enhanced its presence at major trade shows to incorporate interactive experiences for consumers and industry buyers who want to dive deeper into what gives GLOCK handguns their legendary reliability and performance.

IN AN UNIMAGINABLE YEAR OF CHALLENGES, GLOCK CONTINUES TO LEAD THE WAY

2020 WAS A YEAR OF SHOCK, HEARTACHE, AND THE
EMERGENCE OF A WORLD LANDSCAPE NEVER BEFORE IMAGINABLE.
GLOCK EMPLOYEES MET ALL OF IT HEAD ON.

■ ARTICLE BY CHRIS ANTHONY

When most people think of 21st-century industrial innovation and modernized consumer engagement, Silicon Valley startups and high-tech manufacturers are what come to mind. But, there's a lot going on among manufacturers in industries that have been around for decades—ones that to many on the outside seemingly haven't changed the basic processes that get their products to market since the early days of the Industrial Revolution.

With over 9,000 companies and an annual economic impact of over \$60 billion, the firearm and ammunition industry is one of those that's been quietly making strides to integrate leap-ahead business practices and revolutionize customer relations. At the head of this innovation is GLOCK. While it's been the undisputed leader for decades in handgun quality and innovation, GLOCK has taken that same focus on engineering excellence and applied it to the company's manufacturing process, environmental stewardship, and employee security, all with a laser-beam focus on building a lasting bond with its customers in the military, law enforcement, and public communities.

A GLOBAL SHOCK

Perhaps no event in recent history has tested GLOCK's business values more than the onset of the COVID-19 pandemic in the spring of 2020. With mandatory lockdowns, uncertainty over what the future would hold, and worries about personal security, Americans in record numbers flocked to firearm dealers to exercise their right to bear arms. A large number of those buyers were first-time gun buyers, and they were requesting the trusted GLOCK brand.

With guns in short supply across the country, GLOCK pushed forward with daily operations. GLOCK employees kept the recommended six-foot distance from each other, maintained other health-safety protocols, and were still able

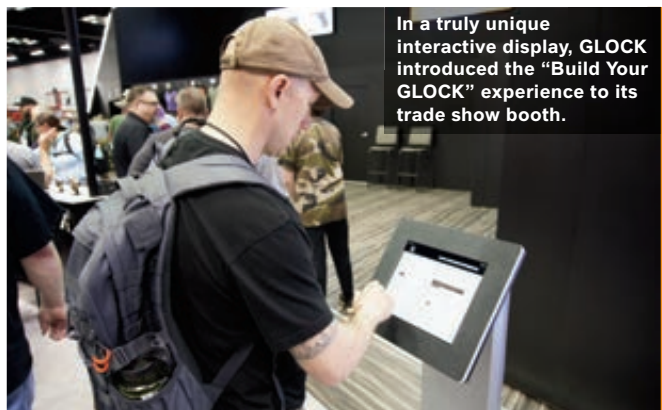

In a truly unique interactive display, GLOCK introduced the "Build Your GLOCK" experience to its trade show booth.

to add production shifts to keep the lines moving, even while other businesses were being forced to close. Underscoring the dedication to their company, more than a few dozen GLOCK employees volunteered to put their regular jobs on hold to take up a position in GLOCK's Smyrna, Georgia, factory to help assemble the handguns Americans trust the most. From the customer-service call center to the warehouse, GLOCK employees with previous experience building firearms raised their hand to meet demand. With the added manpower, the GLOCK factory escalated production by 60 percent without quality reduction. At the same time, GLOCK also made sure to meet the needs of its law enforcement customers so that America's first responders could do their jobs with the confidence of having GLOCK at their sides.

"We are committed to our mission of maximum customer satisfaction during this health crisis," GLOCK Vice President Josh Dorsey said at the time. "GLOCK's adaptability has allowed us to increase production to meet the demand of the market at this time, while implementing necessary precautions to minimize risk to employees and customers."



For the first time, GLOCK has opened its world-class GLOCK Professionals Inc. training operation to the public, allowing civilian shooters access to the same training offered to America's first responders and military units.



GLOCK's reputation for environmental stewardship, its innovative machinery, and an internal culture that feels like family draws crowds to its job fairs at its Smyrna, Georgia, facility.

A FOUNDATION OF EXCELLENCE

Another area in which GLOCK is leading the way for the rest of the firearm industry is in its dedication to environmental stewardship. GLOCK's global facilities have, within the last year, implemented some of the most stringent environmental policies in the space. The company recently put in to practice a comprehensive material recycling program and attained the global ISO 14001 standard for manufacturers that seek "to manage environmental responsibilities in a systematic manner that contributes to the environmental pillar of sustainability."

"Over the past few years, GLOCK recognized that our customers were asking for evidence of our environmental performance," said GLOCK's Global Quality Manager. "Due to an increasing awareness about sustainability, customer desires have changed. Today they wanted products that respond to environmental concerns."

Recycling scrap metal from frames and barrels, repurposing polymer cutouts and castoffs to make pistol boxes, and new energy-efficiency processes to reduce costs and pollution are all now part of GLOCK's model of excellence.

"It is not widely known that GLOCK is already making significant efforts to lower its environmental footprint" GLOCK said. "Our machineries are some of the newest and most energy efficient."

Such moves have prompted others in the firearm industry to take similar actions to streamline their processes, save money, and be better stewards of the environment.

"GLOCK would like to act as a role model within the industry by taking responsibility and setting sustainable actions like the reduction of our energy consumption and the installation of an environmental recycling program," GLOCK said. "The more you can use out of one source, the less you will throw away."



In 2020, GLOCK made a splash with both consumers and the firearm industry when it hosted a live product-launch event for the GLOCK 44, its first .22 LR model.

CUSTOMER FIRST

GLOCK's innovation extends well beyond its workforce and factory. Over the last year, the company has expanded its outreach to new shooters and hard-core fans alike with interactive trade-show displays and a revamped training lineup that extends the "GLOCK Perfection" philosophy beyond the firearm to the shooter themselves.

The company completely redesigned the trade-show booth it uses at critical events and conferences, including the NRA's Annual Meetings and NSSF's SHOT—Shooting, Hunting, Outdoor Trade—Show. That redesign is intended to provide a more engaged experience for visitors interacting with GLOCK staff. It contains an interactive history and timeline of GLOCK product development, including displays of company founder Gaston Glock's original handgun, the "Pistole 80." The Pistole 80, it should be noted, has such lore to GLOCK fans that, as a tribute to its heritage and its followers, GLOCK introduced a limited-edition P80 pistol for GLOCK fans and collectors. This handgun is exclusive to one distributor and features a collector's box and special packaging.

GLOCK also introduced a new interactive feature to the NRA trade-show booth experience, one in which GLOCK fans and those new to its pistols can dive deeper into the company's technology and products. Dubbed the "Build Your GLOCK" customer experience, this section contains an array of interactive displays from which customers can build their own handgun using a variety of GLOCK's innovative components, slides, barrels, and frames.

Recognizing that its customer interactions only begin with a sale, in 2020, GLOCK expanded its GLOCK Professional Inc. training operations. Previously limited to those in law enforcement or the military with specific qualifications, the superb instruction at GLOCK Professional is now available to legions of fans and customers wanting to take advantage of the company's world-class training cadre.

In one last example of the many ways in which GLOCK shows it is keenly focused on its customers, and in what could be a first for the firearm industry, the company hosted a live product-launch event to introduce the world to its innovative GLOCK 44 handgun, the company's first chambered in .22



A piece of GLOCK history. GLOCK has produced a limited-edition remake of the original GLOCK 9x19 Pistole 80, which eventually became the iconic GLOCK 17.



LR. Backed by a multi-channel social-media campaign, a packed house of the industry's top media personalities, officials from the company's headquarters in Austria, Team GLOCK members, and executives from the design and testing shop, the G44 launch was a unique experience for all.

LEADING THE WAY

Whether it's on the factory floor, in the trade-show halls, or on the range, GLOCK is increasingly leading the way in an industry that for too long has taken a backseat in business innovation. From its environmental stewardship and its operational agility during a global pandemic to its increasingly close connection to fans through customer outreach and training, GLOCK continues to live up to its legendary status. ☉



GLOCK's presence at trade shows such as the SHOT Show and NRA Annual Meetings has been designed to provide a personal, interactive experience for all visitors, whether consumer or industry.



CONFESSIONS OF A NEGLECTFUL GLOCK OWNER

■ ARTICLE AND PHOTOS BY BY JAMES REEVES

My name is James, and I have neglected my GLOCK 17.

It is my uncontroversial opinion, as a concealed handgun carrier and instructor, that reliability is the most important characteristic of a carry pistol. Confidence that your handgun will work when needed is essential. That's why I chose a GLOCK 33 in .357 AUTO as my first carry pistol almost 20 years ago. I've lost count of how many different GLOCKS I've personally owned or how many models I've shot since.

Fast-forward about a decade after acquiring that first GLOCK, I was asked by *The Firearm Blog* to co-found our YouTube channel, TFBTV. For one of our debut videos, I took a GLOCK 19, flipped on the GoPro camera, and put the gun in a bucket of mud that had toothpaste-like consistency.

That day, I learned a lesson: If you decide to do something dumb like pumping a G19 full of river silt, with some remedial cleaning and shooting drills, it truly will cycle itself clean.* That sounds *crazy*, but I've demonstrated it in a number of public YouTube videos. The minimal number of parts tends to work contaminants out as the pistol is cycled.

Sometime after that video, I was part of the press pool invited to Smyrna, Georgia, for GLOCK's Gen5 release. I bought a G17 Gen5 shortly after that, which may have been the worst day of its polymer-clad life.

All right, perhaps not that *specific* day. It probably sat in its clamshell for a trouble-free couple of weeks before its internals

were stripped of all lubrication and a half-case of Russian steel ammo run through it—dry. That same day, it was put in a plastic tub and subjected to an unrealistic, leaf-blower-driven artificial sandstorm. The gun ran—*ran*—and the outcome was broadcast on the internet.

Months later, the mistreated G17 involuntarily swam to the bottom of a brackish bayou. When my GoPro captured the moment it was retrieved, wet muck seeped from the frame/slide gap. I charged it up on the spot, and it functioned flawlessly.

A year or so after that, this same GLOCK spent the day in a dry-ice-filled Yeti cooler. Seven hours in a -100 Fahrenheit synthetic tundra only barely prevented the GLOCK from going into full battery for a couple of firing cycles. A gentle motivational bump on the slide plate resolved the issue.

In the summer of 2020, Tropical Storm Cristobal hit New Orleans directly. Rather than let a perfectly good natural disaster go to waste, I locked up the GLOCK in the backyard for two days, cameras rolling. When the storm subsided, I brought this downtrodden pistol to the range, where it ran as many boxes as I'd brought with me without an issue.

Do I unfairly neglect my GLOCK 17? Maybe. Maybe even probably. But it doesn't seem to mind. ☺

*Note: GLOCK does not recommend self-testing under the rigorous conditions as described by the author. GLOCKS that have been subjected to heavy and invasive contaminants should be evaluated by either a qualified gunsmith—preferably a GLOCK Certified Armorer—or by the GLOCK factory where the gun can undergo an extreme cleaning and test-firing under controlled conditions.

SURVIVING FIRE

■ ARTICLE AND PHOTO BY L. JEFFRIES



On July 4, my family and I were in a house fire. We lost everything, but we all made it out safely. I would just like to thank GLOCK for making an amazing product—as you can tell in the picture, my H&K didn't hold up as well in the fire. ☺

CAN'T SINK A GLOCK

■ ARTICLE AND PHOTO BY CARL C.

I just wanted to share that my GLOCK 17 sank in the ocean when I flipped my kayak. There it sat five months, until a fisherman found it and surrendered it to our local police department, which contacted me to pick it up.

The most amazing thing I found after getting it back was that my G17 still fired! There was a little rust and corrosion here and there, but all in all it was back to good working condition after a little clean-up. I've since purchased a firing pin spring and trigger spring, and I recoated the slide and barrel, and she looks great! I am just really impressed by how tough GLOCKS are—all the more reason we trust our lives with them. ☺

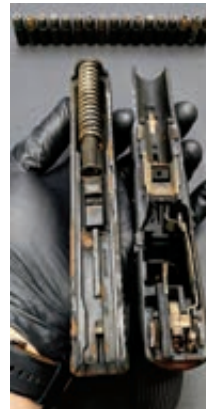



TWO YEARS LOST IN THE MUD? NOT A PROBLEM FOR GLOCK

■ ARTICLE AND PHOTOS BY D. GARNER

I wanted to take a moment to tell you an amazing story I have about my GLOCK 27 Gen4 .40 AUTO. Approximately two years ago, I was fishing in the Apalachicola National Forest outside of Tallahassee, Florida. My fishing pond was deep in the woods, and I got my truck stuck in a large mudhole as I was leaving. I worked for a few hours trying to get out but could not.

When, at midnight, I realized it was time to walk out of the woods, I reached to my side to make sure my pistol was in its holster. It was not! I searched for hours and couldn't find it. I even came back two days later with a "ditch" pump and drained the hole. Still couldn't find it. I looked many more times over the next month but it never turned up. I assumed it was gone forever.

Sometime in the spring of 2020, I was in the same area. It had been extremely dry, so I thought, *Why not?* and checked the area where I'd gotten stuck so many months before.

When I got to the spot, the mudhole had completely dried up and was now just an indentation in the dirt road. But there, at the bottom, I saw a black polymer handle barely sticking above the ground. My pistol!

The pictures show how bad it looked after two years in the mud and dirt. It took a few days of soaking in oil to get the slide to operate, and then, when I was able to field-strip it, I started cleaning the gun and removing rust. It's lost all of the bluing and is slightly pitted in areas, and the striker assembly spring cups were off for some reason, but other than that, no apparent repair was needed.

I put about 200 rounds through it recently without one malfunction—what other manufacturer could make such a claim? Thank you, GLOCK, for a superior product. You have a customer for life! My gun's not pretty because of all its been through, but it's still a superior firearm! 🍷

LOST, FOUND, AND GOOD AS NEW

■ ARTICLE AND PHOTO BY CHIEF CASHIN, FRANCONIA POLICE DEPARTMENT, NEW HAMPSHIRE

In the fall of 2018, my buddy Tony was about to set out on an elk hunt in Montana. He asked if he could borrow my GLOCK 27 so he had something on his person at all times in camp, as the bear warnings in the area were plentiful. I said borrowing the gun wasn't a problem, and Tony departed for his hunt.

Later, I get a visit from Tony. He told me he'd been out in the field and had fallen on some loose rubble down a mountainside. He climbed back up to get all his things, but he couldn't find my GLOCK. He looked until dark but then left to get back to camp.

I called B.S. on his story. If you met the crew of friends I shoot with, you'd know this was a joke right up there with the best of them. So, I say to Tony, "Yeah, *whatever*," and tell him I'll see him at the next monthly match—and he tells me it's not a joke and hands me cash for my gun.

With no other choice, I reported my GLOCK as missing to the Park County Sheriff's Office in Montana. Every few months they'd call me to confirm the gun was still missing. But the next spring, I got a call from Park County, and the lady on the

phone tells me they have my gun! A gentleman out hunting antler sheds found it in the snow and turned it in. I almost lost it—what are the chances? I paid to have the gun shipped and transferred (and then gave Tony his money back), then checked its condition when it arrived. I figured it would be a hot mess after spending a winter on a snowy mountain in Montana, but, nope, it was just fine. The good old Tenifer finish had held up great, and all the internals were fine. I gave it a good once-over, cleaned it, and put it back in service that day. Thanks, GLOCK, for making a great product! 🍷



Shoot Like A Girl!

Empowering Women to Participate in Shooting Sports with Confidence!



#IamGLOCK



The women who've found a home with Shoot Like a Girl wouldn't let a little thing like a global pandemic get in the way of heading to the range and improving their skills.



SHOOT LIKE A GIRL

■ ARTICLE BY TATIANA WHITLOCK ■ PHOTOS BY SHOOT LIKE A GIRL

When it comes to making a positive first impression on first-time women shooters, Shoot Like A Girl has it down to a science. Founded by Karen Butler in 2008, Shoot Like a Girl (shootlikeagirl.com) is dedicated to

growing the number of women who participate in the shooting sports. It operates a mobile, state-of-the-art, military-grade simulated indoor range that travels the country visiting venues like Cabela's, Bass Pro Shops, and various outdoor sporting events. Experienced coaches and NRA-certified instructors work one-on-one with participants to learn the basics of safe equipment handling and marksmanship while shooting a semi-automatic handgun, an AR-platform rifle, and compound bows. The program is designed to ensure that ladies 16 years and up have an experience designed to energize, empower, and encourage them to continue learning about the shooting sports.

The confidence that comes from a safe shooting experience can be life-changing, and since 2008, Shoot Like A Girl has provided that experience to more than 23,000 women across the U.S. "Changing lives one shot at a time" is the mantra above the door of the company's semi-tractor trailer mobile range, and it is evident in the multitude of testimonials it receives.

"A few months ago, an event took place in my hometown that opened my eyes to the fact I wanted and needed a self-defense tool that was going to protect me," said Kendra, a participant from Springfield, Missouri. "I walked away from Shoot Like A Girl with knowledge and understanding. The

women who taught me were clear and precise when talking about gun safety. I can honestly say that, without the hands-on opportunity and amazing conversations I had with the Shoot Like A Girl staff, I might still be too nervous to go to the range, let alone buy a pistol!"

In the spring of 2020, Shoot Like A Girl's nationwide tour was interrupted by COVID-19. Staff quickly adapted to shelter-in-place conditions and put their social-media platforms to work spreading information on the shooting sports with a constant emphasis on safety messaging. Topics included safe firearm handling, kids and guns, the GLOCK Sport Shooting Foundation (GSSF; gssf.org), range etiquette, gun cleaning, archery, hunting, selecting a handgun, and more. The Shoot Like A Girl team even held live-streaming interviews and conversations with influential female industry leaders and competitors like Kim Rhode, six-time Olympian, and Kristy Titus, host and producer of *Pursue the Wild*, keeping the organization's extensive audience engaged and inspired.

With the announcement of the President Trump's "Reopen America Guidance," Shoot Like A Girl implemented new, CDC COVID-19 operation safety procedures and got back on the road. With the unprecedented increase in first-time gun buyers, the instructors saw a drastic surge in demand for training and guidance on how to be a safe and responsible gun owners. Some locations on tour experienced lines of women patiently waiting more than two hours for a chance to work with the team, but clients reported it was worth waiting for and left smiling and eager to learn more! 🌟



Women shooters are pursuing training in self defense regardless the weather conditions. TAW member Goergette Holtzman is undaunted by inclement weather and works on one-handed shooting skills at a TAW range day.

THE WELL ARMED WOMAN RISING TO THE CHALLENGE

■ ARTICLE BY TATIANA WHITLOCK ■ PHOTO BY THE WELL ARMED WOMAN

The Well Armed Woman (TAW), a nonprofit organization, was founded by Carrie Lightfoot in 2012, to be a resource for women seeking knowledge about concealed carry. Initially launched as a website, the organization grew rapidly into a national community of 345 in-person TAW Shooting Chapters across 47 states and embracing more than 11,000 women.

The mission of thousands of TAW members nationwide is to educate, equip, and empower women, via a safe and non-threatening environment, in the effective and responsible use and ownership of a firearm. As firearm sales soar across the country, TAW Shooting Chapters have seen an influx of new firearm owners pursuing guidance and instruction.

"We've learned through our years that uncertainty lights a fire in people, igniting a desire to protect themselves and their families," says Marti Stonecipher, TAW's National Program Director. "These new firearm owners recognize the enormous responsibility that comes with firearm ownership and are actively seeking out the training and education needed to fulfill that responsibility. This search for information often leads women to TAW Shooting Chapters, which welcome them with open arms."

With classes and events filling faster than local trainers can keep up with, TAW has responded by launching a number of new chapters, sometimes in areas not traditionally firearm-friendly. "We expect to see chapters opening at a rate not seen since 2016, the last time there was a major fear about 2nd Amendment rights," said Stonecipher. "We stand by ready to help launch chapters in areas currently in need of compassionate, female-friendly firearm education."

Challenged not only by the surge in demand for its resources but also the mandated COVID-19 quarantines and restrictions, in 2020, TAW broadened its online educational tools to include a web-based library of books related to self-defense and personal protection, video links to additional information sources, and training demonstrations. Chapter leadership also took part in monthly Zoom meetings to stay ahead of the shifting landscape. "At a local level, chapters held virtual meetings to keep in touch with their members, offering them not only training but much-needed camaraderie and fellowship during isolation," Stonecipher explained.

The Well Armed Woman, LLC, also rolled out a new online course entitled "Women & Guns: The Basics," and it formed a partnership with D.R.A.W. Academy (drawacademytraining.com) to bring additional online training opportunities straight to its members' fingertips. Stonecipher emphasized that TAW's biggest achievement of 2020 was its ability to quickly adapt to the constantly shifting and unprecedented times.

While online learning has proven to be an invaluable tool during the global pandemic, there is no substitute for live, hands-on range time. TAW continues to reach its members through state and regional events with the support of GLOCK, a long-time supporter of TAW Shooting Chapters. Not only does GLOCK contribute to the organization's mission, GLOCK staff take part in TAW events and the TAW Annual Leadership Conference, providing first-hand experience with GLOCK firearms and training to the organization's leadership and members. For more information or to find a TAW Shooting Chapter near you, visit thewellarmedwoman.com. 



GLOCK provides guns and gear as prizes for many A Girl & A Gun educational and competitive events.



A Girl & A Gun's membership is climbing rapidly, thanks to the increase in women seeking female-oriented training.

A GIRL AND A GUN FIREARM SAFETY EDUCATION BY WOMEN, FOR WOMEN

■ ARTICLE BY TATIANA WHITLOCK ■ PHOTOS BY A GIRL & A GUN

A Girl & A Gun Women's Shooting League (AG & AG), founded in 2011 by Julianna Crowder outside Austin, Texas, has grown into one of the nation's leading shooting organizations for females. While the initial chapter began as a fun social gathering at a local range, other chapters sprang up rapidly. Today there are multiple chapters in nearly every state. In fact, Crowder and her partner, Robyn Sandoval, have organized A Girl & A Gun chapters at more than 200 indoor and outdoor ranges to meet the demands of women seeking to learn about firearm safety from other women.

"Women are looking for training from other women. They are seeking out a community where they can ask questions safely," said Crowder. "The culture of A Girl & A Gun allows new people to come into a judgment-free zone where they are welcome and feel safe learning."

So successful is the model that A Girl & A Gun has become a nationwide resource for women's self-defense, concealed-carry, competition, and general firearm education. With its judgment-free community of supportive peers and certified trainers, A Girl & A Gun draws over 40,000 women to participate in local, regional, and national events every year. Most notable is that it experienced a record 150-percent increase in memberships in July 2020, mainly attributed to the uncertainty for personal safety brought about by COVID-19.

"When fear in society is palpable due to severe weather events, social unrest, or localized restrictions, the first things to go are milk, bread, and ammunition," said Sandoval, A Girl & A Gun's Executive Director.

The organization was well prepared for the burst in activity at both the national and chapter levels, and it didn't let quarantine orders slow them down for a minute. While events of all sorts were canceled across the country due to COVID-19 restrictions, AG & AG expanded its self-paced digital training programs to keep its members engaged and focused on learning.

Social distancing mandates also couldn't stop the organization from gathering, albeit virtually, for its 2020 National Conference, the largest women's shooting event of the year. More than 400 shooters, spanning new gun owners to skilled competitors, embraced the online venue, logging in from across the U.S. to participate. Top instructors from every shooting discipline contributed prerecorded online courses that shared their knowledge, then came on for a one-hour, live-streamed Q&A sessions. GLOCK's Director of Training, Joseph W. Parent, and the GLOCK instructor team at GLOCK Professional Inc. also participated in the effort. The contribution of material in their "Brilliance in the Basics" presentation emphasized the importance of fundamental pistol skills and was praised by members as a highlight of the 2020 National Conference.

The mission of A Girl & A Gun to educate women about firearm use and safety and promote their interest and participation in the competitive shooting sports continues to evolve. Sandoval said, "2020 was an exciting year for our shooting sisterhood. Thanks to partners like GLOCK, we have reached more women than ever to promote firearm safety and enrich their training experiences." A Girl & A Gun provides hands-on training experiences that bring women together for weeklong events at GLOCK Professional for its Operator and Armorer courses. And, as this magazine was being assembled, competitive shooting events like Fall Fest and A Girl & A Gun's Multi-Gun and Multi-Sport Challenges were scheduled to be hosted at Alabama's Talladega CMP Marksmanship Park thanks to GLOCK's title sponsorship.

Be it digital, classroom, or on the range, A Girl & A Gun continues to grow with the times to meet the ever-increasing interests of women nationwide. Find a chapter near you at agirlandagun.org. ☺



Perfect Your Skills.

GLOCK Professional offers training to law enforcement, military members, licensed security officers and other personnel throughout the U.S. and Canada. Learn how to utilize the GLOCK SAFE ACTION® system to its maximum potential through in-classroom and live-fire range trainings.

Train with the Best.

AVAILABLE CLASSES

Armorer Course (8 hours)
Advanced Armorer Course (16 hours)
Low Profile Carry Course (16 hours)

GLOCK Instructor Workshop (20 hours)
GLOCK Operator Course (16 hours)
MOS Instructor Workshop or Operator Course (16-20 hours)



To learn more and sign up, visit glocktraining.com or contact your local **GLOCK Professional** representative.



Ashley Rheuark



Michelle Viscusi

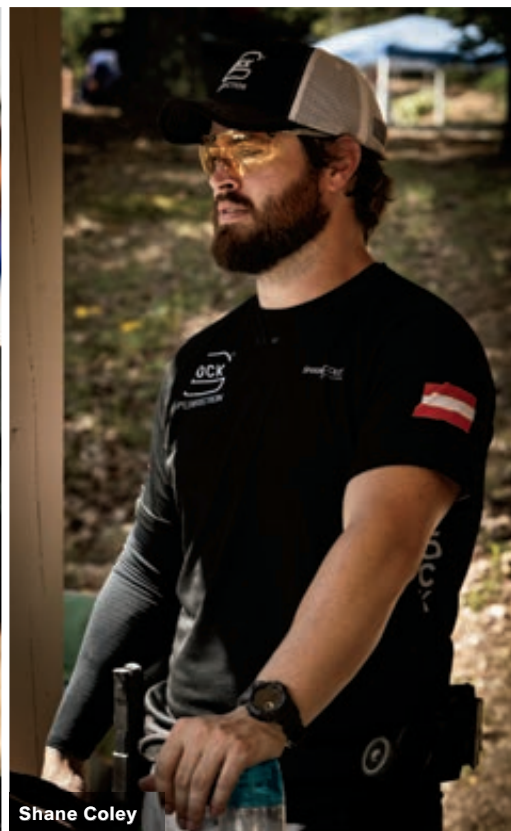

Shane Coley

BEHIND THE SCENES WITH TEAM GLOCK

THE DICTIONARY DEFINES “ECLECTIC” AS “DERIVING IDEAS, STYLE, OR TASTE FROM A BROAD AND DIVERSE RANGE OF SOURCES.” RIGHT NEXT TO THAT WORD, ONE COULD EASILY FIND A REFERENCE NOTE: “SEE TEAM GLOCK.”

■ ARTICLE AND PHOTOS BY RICK STEWART

Shane Coley, Michelle Viscusi, and Ashley Rheuark could not be more wonderfully different. Yet, their successes are found in similarities you might not recognize at first glance.

Each is extremely dedicated to the perfection of their profession. They are not satisfied with average and ordinary, yesterday's success, or even their previous best score. Rather, each is driven to better themselves every day, every match, and every practice. When you think about a company that defines itself with a one-word mission statement—“Perfection”—it's not hard to see why this eclectic group of perfectionists is the perfect fit.

Shane Coley, Team GLOCK Captain, says he wouldn't trade the company he shoots for or his teammates for anything.

“I am truly blessed to shoot for a company that lives up to its mission statement,” he said. “It's not just the teammates I shoot with but every person you encounter in our building, from the custodian to the sales manager, the production worker to the president. Everyone understands that their role in the company is an integral part of making a perfect firearm.”

“Our shooting team is no exception,” Coley continued. “We don't show up to the range and practice to hit bull's-eyes or ‘alphas’ as we call the center box. We try to move as quickly and fluidly as possible while trying to punch those alphas. We are practicing every aspect of movement and shooting in an attempt to beat our personal best every time we step on the range.”

“Every match offers a unique set of targets and challenges,” Michelle Viscusi told me. “We never know what creative nuances a match organizer is going to throw at us. We prepare for everything we've seen and mix things up to be ready for the things we haven't.”

Watching Viscusi move as she shoots hints at something extra, something special about her balance and grace. A gymnast since the age of three and competitive in that sport from the time she was six until she graduated high school, the training discipline instilled by her previous passion is evident.

“Gymnastics has a lot to do with balance, flexibility, grip, and focus,” Viscusi told me. “Those things carry over in important ways to professional shooting, but probably the



“The members of Team GLOCK are not satisfied with ‘average’ or yesterday’s success. They are driven to better themselves every day, every match, and every practice.”



The team members are a family, and they extend that feeling to those they meet on the road. Here, Team Captain Shane Coley takes time to share a great day on the range with some of his youngest fans.



Ashley Rheuark analyzing a stage at a match. She may be the youngest member of Team GLOCK, but she began shooting competitively at age 12 and brings a wealth of talent to the team.

greatest thing I learned at an early age was performing under pressure and having the ability to tune everyone and everything out while remaining intensely focused on the task in front of you.”

Ashley Rheuark is the youngest shooter on the team but not the least experienced. She’s been shooting since she was 10 years old and competitively since she was 12. Her superpower likely comes from the motor-skills memory ingrained in her during years of relentless training and competition. Still, Rheuark says joining the team at just 18 years of age came with challenges.

“When I started with Team GLOCK, one of my parents traveled with me on the road,” she said. “Michelle and Shane probably had no desire to be anyone’s babysitter, and I’m sure that, when I first arrived, they may have worried about how I was going to cramp their style. But, to their credit, they welcomed me in. I never once felt like an outcast or a third wheel. These guys treated me like an equal and have helped me mature and grow in many ways.”

When you watch this team and the way they interact, you are reminded of family. They deeply understand one another’s strengths and weaknesses. They know each other’s secrets too, warts and all—and they would never betray them. They are fiercely loyal to one another, and while they may rib one another with unmerciful banter at times, but, like family, not one of them would let anyone else mess with their teammates.

A DAY IN THE LIFE OF..

At their invitations, I followed each of them at home and on the road to appraise their respective training regimes and schedules. I must admit that, after spending time with them, I was completely blown away with their ability to manage and balance the pace, scheduling, and organized chaos of their lives. Each must deal with individual shooting schedules, personal lives, families, weather challenges, and other factors throughout the year. Through it all, their commitment to training is undeniable. They say that, if you want success, you must put in the sweat and work to create it. There is no luck here.



Ashley Rheuark shows great form during a match. She says, "There's a certain level of stress involved in every match. Those who can harness it are those with the best chance of winning."

ASHLEY RHEUARK

I met Rheuark at the private range in South Carolina where she trains, arriving at 5:00 a.m. to beat the heat and other members. Already in the high 80s and with a helping of oppressive humidity, she admits that weather, wind, and environmental factors can't be allowed to dictate training.

"We experience a lot of different conditions during matches, from bitter cold to sweltering heat. We have rain and wind and

other factors that can throw you off your game if you're not prepared for them," she said. "I train in every condition to be ready for every condition."

Just putting up her targets, Rheuark is drenched in sweat before she even fires her first few rounds.

"Stresses like heat and early morning arrivals are important," she says. "I do like to get to the range early some days because it's nice to beat the heat, if you can call it that. But I also like to get there before other range members who can be distracting. There is a certain level of stress involved in every match. Those who can harness it and get focused are those with the best chance of winning."

Rheuark has won a number of titles and awards, from high lady to match champion. In 2019, she achieved her Grand Master title, an accomplishment garnered by few in the sport.

Of the three shooters on the team, Rheuark would admit she is "kinda-sorta" the biggest nerd. A thin-framed, tomboyish woman on the range, she dons her shooting holster or belt laden with her firearm and enough magazines to keep her feet firmly planted on terra firma. She embraces the perception that some have of her on the range, but she can rock a dress and be all woman when she wants to.

Unlike Viscusi or Coley, Rheuark wasn't an athlete before discovering shooting. While she may not possess the same fluidity of movement or acquired athleticism as her teammates, she certainly makes up for it in course know-how, shooting savvy, and unadulterated skill.

MICHELLE VISCUSI

Michelle Viscusi lives in Arizona, where, on average, daytime temperatures reach over 100 degrees 125 or more days a year. "It's a dry heat," she'll inform you with a wink. "You'll get over it long before you ever get used to it."

Viscusi juggles motherhood, travel, and everything else in her life like the champion she is, but that comes with sacrifices many don't see. When you put the priorities of others over your own, you must find creative ways to make up the time.



Michelle Viscusi is a force to be reckoned with. She says the flexibility, balance, grip, and focus attained through her years as a trained gymnast translate well to competitive shooting.

“We never know what creative nuances a match organizer is going to throw at us,” said Viscusi. “We prepare for everything.”

I attended a barbecue with Viscusi, her family, and friends. After the evening ended, and hours after cleaning up and getting her children to bed, it was nearly 10:00 p.m. before she found time to do lunges on the dark streets of her neighborhood and then begin her lifting routine in her home gym.

Viscusi came to the shooting sports industry after a stint with the Army National Guard where she provided security on the southern border of the U.S. She then took on modeling. She has graced the cover of shooting magazines and others and even landed a spot on the television show *Top Shot*. Amidst her successes with modeling and shooting, she acquired a significant social-media following, one she says has its pluses and minuses, with many who opine unfavorably about females.

“Haters are gonna hate,” Viscusi says. “It can hurt, especially when some of those comments early on came from other shooters in the sport. You can’t stop the uninformed thoughts and diatribes of people who judge with preconceived prejudice. Whether it comes from a place of jealousy or ignorance doesn’t matter. I do my best to ignore what they write and let my performance on the range speak for itself.”

The trophies, titles, and awards she has achieved in shooting should have silenced any critics years ago. She has a physical beauty that captures the attention of others for sure, but the skill she demonstrates on the range quickly becomes the thing everyone is watching at the end of the day.

SHANE COLEY

Shane Coley carves out training time on a private range near his home in Smyrna, Georgia. As a full-time employee of GLOCK in addition to being Team GLOCK’s captain, there’s little time available for using GLOCK’s indoor law-enforcement and military training facility. “Our shooting schedule and public appearances alone create a lot of ‘Xs’ on our calendars,” Coley told me. “There’s not a person on our team who doesn’t wish we had more hours in a day, but we all make the best of the time we have.”

A standout baseball player in high school, an easy road to collegiate opportunities was in the making. Many were surprised when Coley turned down those opportunities for a different path. He attended his first World Match in Bali, Indonesia, at 17. His talent and growing maturity caught the eye of the U.S. Army Marksmanship Unit (AMU), and he was extended an invitation to apply for a spot. He enlisted in 2009 and remained a part of the AMU until 2015, competing around the country and deploying to Afghanistan to provide advanced training for special operations units and warfighters.

Joining GLOCK in 2015 as Team GLOCK’s captain, Coley brought great leadership, vision, and a record of success. But he deflects all praise to the team. “We are successful,” he said, “because every person is committed to the team and one another. We don’t cut each other any slack, and we hold each other accountable. There may be no ‘I’ in team, but we know each individual has a critical role to play.” 🍷



Of his team’s success, Captain Shane Coley says, “We are successful because everyone is committed to the team and to one another. We don’t cut each other any slack, and we hold each other accountable.”



Some would let the words “Team Captain” go to their heads, but not Shane Coley. In between stages, he talks with fans and other competitors, sharing his love for the sport and his job.



Team GLOCK Captain Shane Coley was a standout baseball player in high school and could easily have followed that career path, but competitive shooting is where he found his true calling.



The year 2020 turned out unprecedented firearm sales. Millions of people bought their first ever gun. FFL retailers such as Alamo Gun Works, in Naples, FL sold guns and they were able to offer training, when permitted, due to their investment on-site shooting ranges. They rent and sell guns on presence following all local, state and Federal laws. Photo by Frank Steiger.

FIREARM RETAILERS AND RANGES IT'S ALL ABOUT THEIR CUSTOMERS

TODAY'S GUNS SHOPS AND SHOOTING RANGES HAVE STEPPED UP TO THE PLATE WITH EXCEPTIONAL CUSTOMER SERVICE, NEXT-LEVEL TRAINING—AND A PASSION THAT KEEPS CUSTOMERS NEW AND OLD COMING BACK FOR MORE.

■ **ARTICLE AND PHOTO BY MIKE MACALLISTER, GLOCK COMMERCIAL SALES MANAGER**

The firearm industry is unlike any other, but 2020 likely represents one of the most extraordinary years it's ever had. The pandemic and social unrest that gripped the country for months produced an increase in shooting sports participation and gun sales, according to the the National Shooting Sports Foundation, the industry's trade association. By March, as the pandemic was gaining steam, NICS (National Instant Criminal Background Check System) figures, the number of criminal background checks performed by the FBI for federal firearms licensees (FFLs) conducting firearm sales, showed a year-over-year increase of 80 percent. That equated to more than 6.5 million background checks in the first quarter alone.

With political changes, first-time buyers flooding the market, and new technology rolling out at a steady pace, it's hard to predict which direction the gun industry will take next. But, in meeting with retail gun shops and shooting ranges all over the country, I've been able to listen to their strategies for staying up to date with today's changing customer base, and what they're doing to keep the American traditions of firearm ownership and shooting sports participation alive.

TODAY'S GUN STORES: MORE THAN 'ORDER TAKERS'

Providing the best customer service they can was the top priority I heard from the most successful dealers. Cleanliness of the shop and range and the appearance of their staff were also important, said Vince Vasquez, owner of the C2 Tactical range in Tempe, Arizona. More importantly, Vasquez emphasized that engaging about the responsibilities of gun ownership with their customers is crucial to gaining their trust, and knowledge about the firearms being sold has become a critical training topic for his staff.

Vasquez told me that, in the past, his sales staff had sometimes been referred to as "order takers." Their customers came to the range, having done their own research and knowing exactly what they wanted to purchase. But with the ongoing pandemic and civil unrest during the early summer months of 2020, the range saw an influx of customers who had never shot a gun in their lives. The importance of training and sales-staff knowledge was what helped develop productive relationships with these new customers and provide them with a safe and enjoyable shooting experience.



When a first-time buyer walks into a gun store for the first time, it's critical they have an excellent experience. If they do, that customer will come back to take classes, train often with their firearm, and even start participating in the shooting sports such as the matches of the GLOCK Sport Shooting Foundation (gssfonline.com).

Most first-time buyers purchase handguns. Over time, as they become more involved in the firearm community, they may become interested in rifle or shotgun sports—but to get there, they must have an excellent first impression. Vasquez stated he feels education and training go hand-in-hand with customer service, as does making the customer feel they're part of the greater gun-owning community. Really listening to the customer and guiding them to the right training also help these new gun owners become more motivated to continue their firearm training. So does helping them find the right gear and accessories to fit their self-defense needs or shooting-sports pursuits.

TRAINING—"WE TAKE THIS SERIOUSLY"

Neal Currey, owner and operator at the Ready Gunner in Orem, Utah, reports that new shooters during 2020 were part of his customer base more than ever before, with many specifically seeking concealed-carry firearms. Currey stressed the importance of education and training with these customers. His range program goes a long way toward addressing that need, with customers able to test-fire a variety of makes and models. He says this approach allows the customer to be involved with making the decision about what they like and are comfortable with, instead of being told what's good for them by the person behind the counter.

Applications for concealed-carry permits are at an all-time high with his customer base, Currey told me, so much that his training classes are booked out three months. That commitment to training and safety is something Currey and his staff say is "... a responsibility we take seriously. Educating a new shooter who purchases their firearm from my shooting range is not only a representation of me but the whole Second Amendment community." To keep these new customers invested in their training, customers are provided a free, one-month pass to the range to practice and train upon purchasing a firearm from Ready Gunner.

WOMEN GUN OWNERS ON THE RISE

Sabra O'Crotty, general manager at Rocky Mountain Gun Club in Grand Junction, Colorado, reports about 50 percent of the range's new shooters in 2020 are now women, a remarkable change from the previous balance of 70-percent male. This has been a huge boon to the shooting sports, as women tend to get their entire family involved. Dedicated "ladies nights" have also encouraged women to come in, where they enjoy half-off range time. O'Crotty says the club

also hosts a womens-only concealed-carry class one day a month, something that's been extremely successful, as the class fosters a welcoming environment where women feel comfortable asking questions amongst their peers.

When I asked why she thought women are becoming more interested in the shooting sports, she replied, "Based upon the pandemic and the social unrest, women are now more than ever ready to defend their communities and themselves."

Rocky Mountain Gun Club hosts a full-service firearms range and training department. When a new shooter purchasing their first gun, education moves to center stage, as staff help these customers answer the question, "Now, what?" O'Crotty believes that her range providing an educational experience for all new firearm owners is the future of the shooting sports and protecting the Second Amendment, and it's also one that gets families involved.

PASSION DRIVES A GREAT CUSTOMER EXPERIENCE

Freedom Firearms in Las Vegas, Nevada, is yet another retailer that reported an influx of first-time buyers and new shooters during 2020—and what an influx it was. Owner Mike Jones told me his facility saw a 300-percent increase in the first quarter alone. He spoke highly of his store's customer service, which proudly carries a five-star review by more than 380 customers reporting on their experience with Freedom Firearms.

Jones says it's all about the customer. He'd always had a passion for firearms and had firsthand experience being mistreated by an ego-heavy, down-talking gun dealer early in his firearm education. That prompted him to create a shop where customer service, not gun sales, was the top priority.

It didn't take long after opening his Las Vegas store for his passion for guns and the industry to be discovered by area shooting enthusiasts and Sin City visitors alike. Today, Freedom Firearms is a hugely popular destination for both.

Freedom Firearms carries a wide variety of guns and stressed the importance of the customer's experience when selecting a firearm. Jones and his staff, all avid shooters, prioritize a fun learning environment in which both new and experienced shooters feel welcome. The staff members are dedicated to addressing every customer with enthusiasm and answering all their questions to the best of their abilities.

Jones also expressed his passion for the law-enforcement community. As a GLOCK Blue Label Dealer, he works with law enforcement every day. He told me, "This is something I take very seriously. Becoming a resource to the departments that service my community has become more of a moral obligation than a sales program. In the six years Freedom Firearms has been in business, we've become a trusted partner for the needs of civilian and law-enforcement customers equally, and I am proud of the relationships we have built."

A CHANGING FIREARM OWNER—AND AN INDUSTRY KEEPING PACE

In my travels to ranges and gun stores throughout the U.S., it's plain to see that the industry is rapidly evolving. Range and retail owners alike agree customer service is the focal point of success, noting that their customers' relationships with their businesses allows them to better gauge projections for upcoming quarters and, sometimes, even years. All businesses I talked to reported a massive swell of new customers, and all said keeping them hinges on their treatment, education, and encouragement. Having seen firsthand in my visits and conversations with these ranges and retailers just how focused they are on delivering these things to customers both new and old, firearm owners have a lot to look forward to in the years to come. ☺

GEAR

ESS Eyewear

This company makes excellent eye protection for the shooting sports, with slim designs that work well with ear muff-style hearing protection.



GLOCK Electronic Hearing Protection

Comfortable enough for a long day on the range, these ear muffs from GLOCK offer excellent hearing protection.



Safariland Double Mag Pouch Model 77

This magazine pouch works in both vertical and horizontal carry. Flaps snap together to secure the magazines.



Safariland Open-Top Double Magazine Pouch Model 73

This pouch can be used for vertical and horizontal carry on the duty belt.



Safariland Liner Belt

The Velcro liner attaches to the Velcro on the inside of the duty belt. It helps the duty belt stay in position, especially during movement.

DUTY GEAR DUMP

BY SCOTTY BANKS

Safariland Duty Belt Model 94P

This belt has a hidden brass hook and a hook-and-loop closure on both ends to fasten the belt firmly around my waist.



Safariland Model 7360RDS-7TS Duty Holster

This holster accommodates a weapon-mounted light and a red-dot optic. It also protects the red-dot optic from the elements.

Safariland Belt Keepers

These keep my duty belt from twisting and turning during any physical activity on the range.



Safariland Open-Top Double Magazine Pouch Model 79

With this design, the magazines are oriented face-out to save space on the duty belt.



GLOCK Magazines

Whether training seriously, in competition, or just having some fun on the range with friends and colleagues, you can never have enough spare magazines.



Duty Gear Dump By Scotty Banks:

Scotty Banks has been the Training Manager at GLOCK Professional Inc. since 2016, after first joining the training center as an instructor in 2010. His background includes service with the U.S. Marine Corps, where he served as a Primary Duty Marksmanship Instructor, a role in which he was responsible for unit qualifications and remedial firearm training. After his time in the Marines, Banks pursued a career in law enforcement that now spans more than 15 years. He spent the majority of his career with Georgia's Bartow County Sheriff's Office, where he was a member of the S.W.A.T. Team and was responsible for the team's physical training and shooting program. After 10 years with the Bartow County Sheriff's Office, Banks left to pursue a new career with Adairsville Police Department. He is currently a reserve officer with that agency, and he is also an NRA-certified law enforcement handgun and shotgun instructor.

DUMP

Pilla Panther X7 Sunglasses

These glasses offer complete coverage for safety and protection, as well as a lens filter that enhances targets of different colors..



GLOCK Electric Hearing Protection

This is incredibly comfortable hearing protection, with memory-foam cushions so we can wear them all day.



GLOCK Ranger Hat

The mesh hat allows my head to breathe during the hot summer months. It has a sturdy bill, and front panel that does not deform under the stress the hat endures during a busy shooting season.



Double Alpha Racer Magazine Pouch

This molded-plastic pouch provides positive contact with my magazines. They never fall out during a competition.

Double Alpha Inner/Outer Belt

This belt system is rigid and reliable. I don't have to worry about this belt losing shape or coming undone during competition or training.



COMPETITION GEAR DUMP

BY SHANE COLEY

Henning Wallgren Magazine Extensions

These extensions increase the magazine capacity of my GLOCK 24 magazines to 19+1.



GLOCK Tool

If I need to change parts during a competition, this tool helps ensure a quick fix is at hand.



Double Alpha X Holster

An adjustable holster, the Alpha X locks the triggerguard in place and prevents the pistol from moving in or falling out.



Pro Grip

Using Pro Grip on my hands helps me maintain firm contact with my pistol during shooting, and it helps eliminate sweat during the summer months.

Allen Keys

I have a set of SAE/MM Allen keys as extra tools if anything might happen. They're a universal tool that can benefit anyone.



Leatherman MUT

This multi-tool is another piece of gear that improves my shooter's toolkit and keeps me prepared to deal with whatever may happen on the range.



Competition Gear Dump By Shane Coley:

Shane Coley is the Captain of Team GLOCK, and he's been with GLOCK since May 2015. Born and raised in Greenville, Mississippi, he was an avid baseball player throughout his childhood and into high school, and he began pursuing a professional shooting career when he was 14 years old. Upon graduating high school, he enlisted in the United States Army, joining its elite Army Marksmanship Unit (USAMU) as a member of its Action Shooting Team. The team competed all around the world and supported training of U.S. military forces in difference capacities. Coley spent seven years as a member of the USAMU Action Shooting Team before being approached with the opportunity to become Team GLOCK's newest Captain. In addition to competing around the year, he is a full-time college student at Kennesaw State University, where he's pursuing a degree in international business.



Classes taught by GLOCK Professional instructors aren't for those who take their training lightly. A dedication to pistolcraft and constantly improving skills is a must for those who attend.

GLOCK PROFESSIONAL, INC. A PERFECT MATCH TO A WORLD-CLASS GUN

WHEN A TEAM OF TRAINERS IS FOCUSED SOLELY ON HELPING OTHERS GET THE MOST OUT OF THE MOST REPUTABLE GUNS ON THE PLANET, EVERYONE COMES OUT AHEAD.

■ **ARTICLE BY CWO-5/GUNNER CHRISTIAN P. WADE, USMC (RET.)**

Imagine having purchased the most highly engineered and operationally proven service pistol in history. Then imagine the training and education required for the human operator to fully capitalize on this pistol's capabilities.

It is no coincidence that GLOCK, the producers of the world's finest service pistol, and GLOCK Professional, Inc., the trainers and educators thereof, are located together in Smyrna, Georgia. Fortunately for us all, the experts of GLOCK Professional "have gun and will travel" to anywhere there is a request for knowledge and training.

When I ponder the world-class capabilities of GLOCK SAFE ACTION® pistols and compare them with the complex defensive demands of military personnel, law enforcement professionals, and private citizens, GLOCK Professional presents front and center.

To illustrate this, I turned to the U.S. Department of Defense's systemic analysis tool: DOTMLPF-C. The initialism draws from "doctrine, organization, training (and education), materiel, leadership, personnel, facilities, and

cost (budget)." In this case, GLOCK pistols are the materiel selected after rigorous testing, data analysis, and development requirements—all based on doctrine, personnel, and cost.

For many years, as a U.S. Marine Corps DOTMLPF-C developer, I found my problems most often start with "P" and "T"—personnel and training. Simply stated, many agencies and private citizens were already issued or owned the state-of-the-art service pistol—the GLOCK—and once GLOCK pistols are procured, the easy part ends.

So, now we own or are issued a world-class service pistol. We are fully operational now, right? Negative. We have only just begun to appreciate the responsibility of training and educating ourselves and others with it—and where better to seek this training and knowledge than directly from the source, GLOCK Professional.

On what evidence do I base this claim? I recently attended training at the GLOCK Professional facility in Smyrna. Within my first magazine of live-fire, the instructor respectfully identified an inefficiency in my basic shooting technique. He



Those taking part in GLOCK Professional instruction learn more intuitive and effective techniques that elevate their skill levels.

“When I walked through the door of a recent GLOCK Armorer’s Course, I thought I knew all there was to know about GLOCKs. GLOCK Professional instructors politely showed me the errors in my ways—and I am better for this.”



GLOCK’s Armorer’s and Advanced Armorer’s courses take a deep dive into everything that makes these pistols tick. (Photo by J. Amelle)

then showed me an intuitive and more effective technique and, most importantly, explained the reasons for making the change by offering operationally gained credible evidence. The instructor then allowed me to focus on full integration of this skill through supervised repetition. Within five minutes, the instructor had shown me a simple technique to further capitalize on the engineering brilliance of my GLOCK.

After 40 years of pistol training, many of them in a professional military capacity, my battle-proven ego suggested to me that I knew everything. Perhaps the most counterintuitive realization resulting from my experience with GLOCK Professional training is that I deeply enjoyed the demanding training and camaraderie. I was grateful to the instructor for helping me become more proficient and knowledgeable.

Upon inspection of the GLOCK Professional training website (GLOCKTraining.com), one quickly deduces that this group maintains a no-nonsense approach to training and education. It offers the following courses:

- Armorer’s Course: Instruction in proper use and maintenance of GLOCK pistols.
- GLOCK Operator Course: Knowledge and skill building with GLOCK pistols.
- GLOCK Modular Optic System (MOS) Course: Training on GLOCK MOS systems.
- GLOCK Low-Profile Carry Course: Concealed Carry techniques and skills.
- Instructors Workshop: Education for current firearm instructors.
- GLOCK Modular Optic System (MOS) Instructors Workshop: Dynamic MOS training.
- Advanced Armorer’s Course: Highly detailed training for current GLOCK Armorer’s.
- GLOCK 18 Select-Fire Pistol Course: Law enforcement training with the G18.

These courses provide the “how” and the “why” that serve as the integrator of the DOTMLPF-C materiel (GLOCK pistols) with the training, education, and personnel (you and me).

The Armorer’s Course, for example, provides an in-depth education in the engineering of all GLOCK pistol generations. When one fully understands what is physically happening inside the complex machine, one better comprehends operational care and maintenance in order to efficiently diagnose various issues and maximize reliability.

These issues are most often operator-induced. For example, most shooters, myself included, have experienced operational stoppages (with any pistol), and we may be quick to suspect the gun. Once correctly trained and educated, though, we sometimes discover that our improper manipulation of the pistol, as a result of insufficient training and incorrect technique,

has been the cause of the problem, rather than the gun itself.

There is an old saying in the U.S. Marine Corps: “It’s not the dope (an old-fashioned term for sight settings) on the gun, it’s the dope (knucklehead) behind it.” In other words, as competent as my ego likes to tell me I am, seldom do I employ GLOCK pistols to their full potential.

Many of us depend on our GLOCK pistols for our continued well-being and survival. When I walked through the door of a recent GLOCK Armorer’s Course, I thought I knew all there was to know about GLOCK engineering and tactical shooting. GLOCK Professional instructors politely showed me the errors in my ways, and I am better for this.

Owning and operating the world’s finest service handgun is unlikely to, for its own sake, make an owner/operator more credible and effective. I suggest burning through the anecdotal static generated on internet forums and social media and, instead, go directly to the credible source of education and training for the GLOCK pistol, GLOCK Professional, Inc., which now offers a variety of courses to qualified members of the general public. Shooting, learning, and training with these instructors has not only taken my professionalism to a much higher level, I have thoroughly enjoyed the experience. Try it. I believe you’ll find that you, too, can maintain the highest levels of self-discipline, safety, life-long learning, and rigorous training, while still having fun. ☺



Photo by Author



Photo by Author



NEW GUN OWNERS FIND FUN, FAMILY, AND COMPETITION WITH GSSF

BECOMING INVOLVED IN COMPETITIVE SHOOTING CAN BE INTIMIDATING FOR NEW GUN OWNERS. BUT WITH A GLOCK SPORT SHOOTING FOUNDATION MEMBER BY YOUR SIDE, YOU'LL HAVE NOTHING BUT THE TIME OF YOUR LIFE.

■ ARTICLE BY MEGHAN R. LOWERY

Ask shooters who compete in the GLOCK Sport Shooting Foundation (GSSF) what keeps them coming back, and you'll get various answers. But ask shooters what brought them to their *first* GSSF competition, and the answer is most often, "I knew someone who shoots GSSF!"

This is a critical admission and an essential component to the future of GSSF and all recreational shooting sports. Why? Because every GSSF competitor, at every level, has the opportunity to impact the future by introducing a wave of new competitors to the world of shooting competition.

GSSF, by its very nature, has a low "criteria of entry." If you own or can borrow a GLOCK and can safely operate it, you can compete. This is not necessarily the case with other competitive shooting events, which can require advanced handling abilities, movement, and often expensive gear, tools, and accessories, and even special clothing. Those things can deter newer shooters from beginning to compete.

While GSSF is certainly beginner-friendly, it retains a competitive edge for advanced shooters. The thrill of competition and self-development also benefit the experienced shooter.

Because GSSF matches are designed to be inclusive, available, and entertaining to firearm owners of all skill levels, they serve as a jumping-off point for a number of things. They get people new to the shooting sports—whatever their abilities, desires, or competitive nature might be—on the range, practicing, and meeting others who can show them the ropes. Practice, as we all know, is key to perfecting your gun handling skills and becoming confident in your abilities, and with that confidence comes greater enjoyment in shooting.

Because GSSF is so accessible and fun, it's common for new shooters to start out with GSSF matches and then become involved in other shooting sports disciplines as their skill levels improve. You know what they say, there's strength in numbers. Increasing participation in the shooting sports now is crucial to continuing our enjoyment of them in the future.



FIRST MATCH? NO WORRIES. THERE'S LOTS OF HELP

As beginner-friendly as GSSF is, joining in can still be intimidating to someone new to firearm handling. The importance of experienced shooters getting those new shooters over the hump, as it were, cannot be underestimated. I interviewed several shooters for this article who recently began competing in GSSF. One of them, Morgan Cross, splits her time between Indiana and Florida. She noted that her family members, especially her father, were instrumental in getting her into the world of competitive shooting through GSSF. It also allowed her to bond with her father over their mutual love of firearms.

The environment at most GSSF events is also critical to imparting the feeling of inclusion on newer shooters. Cross advised those looking to get involved, “Don’t be afraid to ask for help! Everyone is super helpful, super informative. It feels like you could walk up to any person and they would be willing to help you. Lots of people will answer questions, reach out and talk to you, and even help you with strategies for shooting certain stages.”

Lindsey Pittenger, from Alabama, also offered advice. “Be prepared for the GSSF range rules to be a little different than what you might have encountered at other ranges, such as the process of clearing your firearm—inspect the chamber, slide forward, hammer down/press the trigger, store the firearm—but as soon as you get used to it, it’s easy,” she said.

Matthew Pittenger, Lindsey’s husband, agreed and mentioned that he was reminded by a GSSF staff member to dry-fire practice when switching from one type of division to another—for example, from pocket to civilian—that might require a different number of shots. “Also, keep in mind that slow is smooth and smooth is fast,” he remarked, commenting on a remedy for the tendency of many new match shooters to rush their shots, forgoing accuracy in the process.

After the initial learning curve of becoming familiar with GSSF match registration, signing in at each stage, marking yourself present when you are ready to shoot, completing the forms, and coming prepared with loaded magazines, it becomes easy to understand and navigate the matches. To further enhance a new competitor’s confidence and capabilities, they are certainly welcome to serve as a Range Officer (RO) and learn valuable skill sets from other ROs and competitors they meet throughout the day. Marcus Christian, from Mississippi, said he learned quite a bit from serving as an RO, in addition to his first time shooting a GSSF match. Spending time as an RO also helps a new competitor develop friendships with the others

they meet and interact with at the matches, and it enhances understanding of the match structure. In other words, you’re never shooting a GSSF match without lots of people to help you get comfortable and show you how much fun it can be.

DID WE TELL YOU ABOUT THE PRIZES?

Speaking of fun, the opportunity to win prizes—no matter your score—is a *huge* bonus to shooting GSSF. Random gun drawings, prize money, “swag,” and other prizes are a great draw for experienced and new shooters alike. Christian excitedly told me that he’d won a free GLOCK prize for range officers and was planning on using the certificate to purchase a GLOCK 44. The prizes offered also benefit from new-shooter recruitment, because the more shooters in attendance at a match, the more prizes GSSF provides. And because so many of the prizes are given away randomly, shooters of all abilities, not just those at the division tops, benefit from additional shooters attending the matches. More people, more prizes, more winners.

Free guns and gear are great, but the ultimate prize is discovering the friendliness and camaraderie of fellow shooters and your match’s range officers. Lindsey Pittenger told me that a fellow shooter let her borrow a magazine reloading tool after her fingers grew tired. Matt Pittenger mentioned how grateful he was that one GSSF staff member was there with he and his wife every step of the way through their first match.

Of course, to begin shooting competitively, you have to get to a match in the first place. For the Pittengers and others I spoke with, what ultimately drove them to take that step was a fellow shooter who encouraged them to attend a match. Hearing similar anecdotes from so many, it became clear to me that shooters already involved with GSSF play a critical role in building connections with shooters who have not yet explored competition.

REPRESENTING THE DIVERSITY OF TODAY’S FIREARM OWNERS

If you shoot GSSF, I encourage you play a part in the recruitment of new shooters, especially those considered “non-traditional.” That’s important, because increased diversity in recreational shooting better reflects the diversity in gun owners. Statistics abound regarding the number of non-traditional firearm owners: Today, there are more women, more minority group members, younger shooters, and certainly those with diverse political interests, educational backgrounds, jobs, and incomes. Individuals who own a gun now are much more likely to have *not* grown up shooting with family or friends, with many becoming first-time gun owners for self-protection and home-defense. Getting involved in competition works to enhance their safe firearm handling skills, as well as their self-defense skills, and that’s a plus for the entire firearm-owning community.

If you are a current GSSF shooter, you are well prepared to become a fantastic recruitment officer. As I’ve said and so many have told me, people so often become involved in GSSF because they know someone who’s already participating in GSSF matches. *Be* that someone. Encourage new competitors to come out and experience GSSF. If you’re a new GLOCK owner reading this and just getting to know your firearm and firearm safety, take this as a sign to get to a match and join in on the fun—we promise you’ll be hooked! And just in case either side needs a little more incentive, when a current GSSF member brings a new person with them to a match, both will be entered in a drawing for a GLOCK pistol certificate. Now isn’t that a win-win for everyone? For details, visit gssfonline.com. ☺

2021 GSSF MATCH SCHEDULE

*Subject to change

DATE	MATCH NAME	HOST CLUB	WEBSITE	RANGE ADDRESS/CONTACT
JAN 23-24	The East Ascension GSSF Challenge V	East Ascension Practical Shooters		9134 S. St. Landry Dr., Gonzales, LA 70737; keith_lemoine@yahoo.com
JAN 23-24	Smokin' GLOCK Southwest Regional IV	The Smokin' Gun Range	www.thesmokinggunclub.com	9970 E. Peppermill Palms Blvd., Littlefield, AZ 86432; thesmokinggunclub@gmail.com
FEB 5-7	Volusia County GSSF Match IV	Volusia County Gun & Hunt Club	volusiacountygunclub.com	4846 E. SR 44, New Smyrna Beach, FL 32168; mrglkl@gmail.com
FEB 13-14	Charleston GLOCK Challenge XI	Palmetto Gun Club	palmettogunclub.org	761 Summers Dr., Ridgeville, SC 29472; h8spvmt@gmail.com
FEB 13-14	GLOCK's On The Brazos	CCC Shooting Complex	cccshootingcomplex.com	9000 Bob Moore Rd., Navasota, TX 77866; charles@cccshootingcomplex.com
FEB 20-21	Northern Florida Regional Classic VIII	Talon Range	talontraininggroup.com	550 Commerce Blvd., Midway, FL 32343; charlie@talontraining.com
FEB 27-28	Benton Gun Club GSSF Challenge VI	Benton Gun Club	bentongunclub.org	5522 Mt. Olive Cutoff Rd., Bauxite, AR 72011; howard81@sbcglobal.net
MARCH 6-7	The Ouachita Regional Challenge XI	Ouachita Parish Sheriff's Public Range	opso.net/public-range/	357 Sheriff Fewell Rd. W., Monroe, LA 71292; bacleopso@hotmail.com
MAR 12-14	River Bend Ballistic Challenge IX	River Bend Gun Club	rbgc.org	2234-240 River Bend Gun Club Rd., Dawsonville, GA 30534; roadkill751@yahoo.com
MAR 12-14	Delaware State GSSF Challenge VI	Bridgeville Rifle & Pistol Club	bvill-rifle-pistol.org	10409 Rifle Range Road Bridgeville, DE 19933; rj7257866@gmail.com
MAR 20-21	Northern California GLOCK Challenge XIII	Yolo Sportsmans Association	yolosportsmansassociation.com	24001-25799 Aviation Ave., Davis, CA 95616; rvsechlerjr@gmail.com
MAR 20-21	Emerald Coast GLOCK Classic II	Southern Tactical Range	southernrangerange.com	4418 Cooper Ln., Holt, FL; curtispbo@gmail.com
APRIL 10-11	Table Rock Challenge IX	Burke County Narcotics Task Force		2500 Marsh Trl., Morganton, NC 28655; alexcobb49@yahoo.com
APRIL 10-11	GLOCK West Coast Challenge VI	Calguns Shooting Sports Association	cgssa.org	22100 East Fork Rd., Azusa, CA 91702; jacob@cgssa.org
APRIL 17-18	Gem State Classic VII	Nampa Rod & Gun Club	nragc.com	7990 Bennet Rd., Nampa, ID 83686; philsaute36@gmail.com
APRIL 17-18	Homestead GLOCK Challenge V	Homestead Training Center	shoottc.com	11700 SW 304 St., Homestead, FL 33033; ricklunds@gmail.com
APRIL 24-25	Lone Star Classic XXVII	Dallas Pistol Club	dallaspistolclub.com	1830 W. Belt Line Rd., Carrollton, TX 75006; rcmathews@sbcglobal.net
MAY 1-2	"This is Sparta" Challenge X	World Shooting Complex	dnr.ilinois.gov/recreation/WSRC	1 Main Event Ln., Sparta, IL 62286; bartcarson71@gmail.com
MAY 1-2	Cornhuskers Classic XIII	Heartland Public Shooting Park	grand-island.com	6788 W. Husker Hwy., Alda, NE 68810; bilst@grand-island.com
MAY 8-9	Sweet Home Alabama GLOCK Challenge IX	Central Alabama Gun Club	centralalabamagunclub.com	34791 Co. Rd. 2, Shorter, AL 36075; joe.peel@gmail.com
MAY 15-16	Music City Shootout XI	Music City Tactical Shooters	mctclub.com	30 Elk Ridge Rd., Mt. Pleasant, TN 37055; jmbresson@hotmail.com
MAY 22-23	Northern Lakes Regional Classic XXX	Oakdale Gun Club	oakdalegunclub.org	10386 10th St. N., Lake Elmo, MN 55042; mdmurphy@frontier.com
MAY 22-23	Belton Blast II	Belton Gun Club	beltongunclubinc.wildapricot.org	153 Range Rd., Belton, SC 29627; goodfellowdon@aol.com
JUNE 5-6	Big Sioux Ballistic Challenge X	Big Sioux Rifle & Pistol Club	bigsiouxrifleandpistolclub.com	25951 484th Ave., Valley Springs, SD 57068; safirearmtraining@gmail.com
JUNE 5-6	BSR GLOCK Challenge	BSR	bsr-inc.com	201 Motorsports Park Cir., Summit Point, WV 25446; glittrell@bsr-inc.com
JUNE 12-13	GLOCK Fire on the Mountain VII	Daisytown Sportsmen's Club	daisytownsportsmensclub.com	198 Fulmer Rd., Johnstown, PA 15904; mouseclicks@atlanticbb.net
JUNE 12-13	Beaver State Ballistic Challenge XXVI	Chehalem Valley Sportsman Club	cvs.c.us	9401 NE Worden Hill Rd., Dundee, OR 97115; mkgoss@hotmail.com
JUNE 19-20	Garden State Regional Classic XXVII	Central Jersey Rifle & Pistol Club	cjrpc.org	161 S. Stump Tavern Rd., Jackson, NJ 08527; MrGlock89@aol.com
JUNE 27-28	Montana GLOCK Classic XVI	Western Montana F & G Association	wmfga.org	101-329 Deer Creek Rd., Missoula, MT 59802; sdbair@yahoo.com
JUNE 27-28	Rock the GLOCK II	Dead Zero Shooting Park	deadzeroshooting.com	1195 TN-111, Spencer, TN 38585; svictor@deadzeroshooting.com
JULY 10-11	Scarborough Fish & Game Annual GSSF Match IV	Scarborough Fish & Game Association	www.scarfg.org	21 Fish & Game Ln., Scarborough, ME 04074; pfm1911@gmail.com
JULY 10-11	Couer D'Alene GLOCK Classic II	Fernan Rod & Gun Club	frgc.org	11400 E. Fernan Lake Rd., Couer D'Alene, ID 83814; timccc68@gmail.com
JULY 17-18	Buckeye State Ballistic Challenge XXIX	Ft. Harmar Rifle Club	fortharmar.com	3265 Fifteen Mile Creek Rd., Marietta, OH 45750; gunstock@hughes.net
JULY 24-25	Great Lakes Regional Classic XVII	Livingston Gun Club	livingstongunclub.org	2406-2412 Hunter Rd., Brighton, MI 48114; arotechwelding@mi.rr.com
JULY 24-25	Pacific Coast Challenge XV	Albany Rifle & Pistol Club	arpc.info	29999 Saddle Butte Rd., Shedd, OR 97377; excedirector@arpc.info
JUL 31-AUG 1	Virginia Ballistic Challenge III	Triangle Sportsmen's Club	triangleonline.org	770 Triangle Rd., Bluefield, VA 24605; rmartin65@yahoo.com
JUL 31-AUG 1	Northwestern Regional Classic XXVI	Jefferson County Sportsmen's Assn.	jeffersoncountysportsmen.org	112 Gun Club Rd., Port Townsend, WA 98368; p9baja@gmail.com
AUG 7-8	Magic City GLOCK Challenge VI	Billings Rod & Gun Club	billingsrodandgun.org	2931 Rod & Gun Club Rd., Billings, MT 59106; ntibesar@langlas.com
AUG 7-8	Rocky Mountain Regional Classic XXVII	Weld County Fish & Wildlife Range	wcfw.org	38980 Co. Rd. 51, Eaton, CO 80615; wayneseale@hotmail.com
AUG 14-15	Eastern Nebraska GLOCK Classic VI	Eastern Nebraska Gun Club	engc.us	12700 NE-66 (Hwy. 66), Louisville, NE 68037; cmzeeb@gmail.com
AUG 21-22	Keystone State Ballistic Challenge XXV	Topton Fish & Game Association	toptonfga.org	26 Tina Ln., Mertztown, PA 19539; lciletti@gmail.com
AUG 21-22	Midwest Regional Classic XXX	Green Valley Rifle & Pistol Club	gvshoot.com	4350 E. Academy Rd., Hallsville, MO 65255; amanda.jo.brown88@gmail.com
AUG 21-22	Northern California Regional Classic XXVIII	Richmond Rod & Gun Club	richmondrodandgun.com	3155 Goodrick Ave., Richmond, CA 94801; rmcknig@ur.com
AUG 28-29	Twin Tiers Regional Classic VII	Pine City Sportsmens Club	pinecitysportsmensclub.com	187 Mountain View Dr., Pine City, NY 14871; alan@rusticwoods.net
SEP 17-19	GLOCK Annual Shoot XXVII- Gunny Challenge XVII	Civilian Marksmanship Program	thecmp.org	4387 Turner Mill Rd., Talladega, AL 35160; jhardy@thecmp.org
SEP 25-26	Badger State Regional Classic XV	Schultz Resort Rod & Gun Club	schultzgunclub.com	W146 S8025 Schultz Ln., Muskego, WI 53150; garywblum@yahoo.com
OCT 2-3	Showdown at Big Creek X	Mobile County Sheriff's Office Range	mobileso.com	12251 Tanner Williams Rd., Mobile, AL 36608; dcrobinson@mobileso.com
OCT 9-10	Atomic City GSSF I	Los Alamos Sportsmans Club	la-sc.org	Rendija Rd., Los Alamos, NM 87544; das32985@gmail.com
OCT 9-10	Western Wisconsin GLOCK Classic VII	Holmen Rod & Gun Club	holmenrodandgunclub.com	W7503 Co. Rd. T, Holmen, WI 54636; brian.swartling@gmail.com
OCT 16-17	The Sunflower State Classic IX	Trigger Guard	triggerguardonline.com	313 N. Meridian Rd., Wellington, KS 67152; mike@triggerguardonline.com
OCT 16-17	Bluegrass Regional Classic XXIV	Bluegrass Sportsmens League	bgsinc.com	2431-2445 Handys Bend Rd., Wilmore, KY 40390; kygssf@gmail.com
OCT 23-24	Hoosier State Regional Classic XXIV	Atlanta Conservation Club	atlantaconservationclub.com	29595 Leonard Rd., Atlanta, IN 46031; glock17202634@yahoo.com
NOV 5-7	The GLOCK Showdown in Savannah IV	17 South Rod & Gun Club	17southrngclub.com	5899 N. Coastal Hwy., Fleming, GA 31309; arpeters82@yahoo.com
NOV 6-7	Duel in the Desert XV	Tucson Rifle Club	tucsonrifleclub.org	18303 W. Tucson-Ajo Hwy., Tucson, AZ 85735; ssdnkld15@aol.com
DEC 5-6	"Remember the Alamo" Ballistic Challenge XXVI	Blackhawk Shooting Range	blackhawkshootingrange.com	12137-12195 Jarratt Rd., Atascosa, TX 78002; blackhawkrange@yahoo.com



ESSENTIAL CARRY: THE GLOCK LOW-PROFILE OPERATOR

IF YOU HAVE A GLOCK AND CARRY CONCEALED, YOU NEED THIS COURSE.

■ BY CHRIS EDWARDS

The year 2020 witnessed an increasing number of citizens purchasing firearms, and many of those buyers were seeking to legally carry firearms for self-defense. Most such purchasers pursue concealed, or “low-profile,” carry, much as law enforcement and military personnel also find it beneficial to be discreet in the carry of weapons.

GLOCK Professional, Inc. has introduced a refinement to its GLOCK Operator Course that specifically addresses the techniques necessary for the successful low-profile deployment of GLOCK pistols. Meeting in March 2020, GLOCK instructors put the course and themselves to test and validate it.

The lead instructor for this effort was the Director of GLOCK Professional, J. “Willie” Parent, who was assisted by GLOCK’s Training Manager, Scotty Banks. Both have deep ties to the U.S. military and law-enforcement communities and many training hours under their belts. They also both carry concealed whenever they can.

The newly designed Low-Profile Carry Course was run through in its entirety by the evaluation team, with a shooting test at the end. Both outdoor and indoor environments were utilized, the better to work through various layers of concealment clothing. At the completion of the course’s vetting, all GLOCK Professional personnel were certified in the course.

BEYOND THE BASICS

To be clear, the new Low-Profile Carry Course is not “basic” instruction in safe firearm handling and deployment. Applicants

are vetted before attending and are required to demonstrate proficiency so that course instructors know they will be able to successfully absorb the content and complete the class.

The course is a full two days and requires 1,000 rounds of ammunition, each attendee’s GLOCK of choice, and necessary safety equipment. There is a classroom session the first morning, and then everyone is off to the range.

Those who have attended the original Operator Course will recognize that the structure of the Low-Profile Carry Course begins with the comprehensive “GLOCK Standards” shooting evaluation and rating. One becomes, as GLOCK Professional instructors put it, “brilliant in the basics” of pistol-craft if focus and effort are applied. From there, the myriad details of concealed carry are discussed and techniques executed in progressive range drills. The results are clear improvements in fundamentals and performance.

All GLOCK Professional instructors brought their real-world experiences to developing this new course and becoming certified in it. That’s critical for two reasons: First, they experienced all the element to which students would be exposed. And second, in doing so, they become part-owners of the course, something that can only lead to a positive, dynamic program.

If one has experience with carrying their GLOCK concealed, this course is a must-attend. It just could save your life or the life of someone for which you’re responsible. Courses across the country are available, and you’ll find them listed at [GLOCKTraining.com](https://www.glocktraining.com). Don’t hesitate—get to one as soon as you can. ☉



As a new gun owner, it is critical that you learn how to safely and competently handle and store your firearms.



Retail firearm stores across the country are tremendous resources for learning about how your guns work and discovering the shooting sports.

CALLING ALL NEW FIREARM OWNERS WE'RE HERE TO SHOW YOU AROUND!

IN THIS ERA OF INCREASING DIVERSITY, MILLIONS OF YOU HAVE CHOSEN TO BECOME FIREARM OWNERS FOR THE FIRST TIME—AND THE MILLIONS WHO CAME BEFORE YOU ARE HERE TO GUIDE YOU TO A LIFETIME OF SAFE, RESPONSIBLE ENJOYMENT WITH THEM.

■ ARTICLE BY CHRIS EGER ■ PHOTOS BY FRANK STEIGER

Data from firearm industry trade groups and federal regulators point to millions of first-time gun buyers joining the ranks of Americans exercising their right to keep and bear arms in 2020. That's tremendous news in and of itself, but even better is the fact that many of these first-time gun owners are increasingly diverse groups, including women and minorities.

The FBI's National Instant Criminal Background Check System (NICS), the system that vets the background of potential firearm buyers against a host of federal, state, and local criminal and military databases, reported record numbers of checks through the first three quarters of 2020. Repeatedly, NICS churned out its highest monthly and weekly totals since the system was activated in 1998. By the end of September 2020, the last point at which we had data before this *GLOCK Annual* went to press, NICS had recorded more than 28 million firearm background checks for the year, beating 2019's full-year total with three months still left to go in 2020.

The data, confirmed by the National Shooting Sports Foundation (nssf.org), the firearm industry trade association, and checked against surveys of firearms retailers, found that 40 percent of firearm sales were to those buying a gun for the first time. Similarly, nearly 40 percent of those first-time sales, according to survey respondents, were to women, while the average sales increase to minorities hovered around 50 percent.

"This is a tectonic shift in the firearm and ammunition industry marketplace and a complete transformation of today's gun-owning community," said Lawrence G. Keane, NSSF Senior Vice President and General Counsel.

Going deeper, NSSF found that sales of semi-automatic handguns were the most popular, outpacing those of the next

closest category of firearms, shotguns, by a nearly two-to-one margin. The main reason cited by consumers for their firearm purchases during 2020 was for personal protection.

Data collected from GunGenius.com, which reflects firearms sold on GunBroker.com, the largest selling platform of on-line firearms, shows that the top-selling pistols month after month for 2020 were GLOCKS. It emphasizes the brand as a go-to choice for consumers and sets a benchmark against which others are judged.

With millions of new gun owners joining the American shooting community, what's next? You can start by finding the perfect GLOCK for you (page 50-51). Of course, with a firearm comes the tremendous responsibility to keep it properly secured when not in use (page 52-54). Next comes learning about and understanding your handgun—how it functions, the names of its parts, how to clean and maintain it—all of which can be answered by the GLOCK owner's manual; if you bought a used GLOCK, that manual is available at us.glock.com/en/downloadable-materials. Then comes training in the shooting fundamentals (page 47), which you will rely on each time you use your gun or any other. When you discover just how much fun shooting is, you can then research the many assets (page 48-49) and organizations like the GLOCK Sport Shooting Foundation (page 42-43) that can be a new gun owner's best friend.

Don't forget to check back in with your local gun stores and shooting ranges to keep on top of the latest trends, support, and training (page 36-37). With those businesses you'll also find the common thread running through America's culture of firearm ownership, one that is inclusive and more than happy to embrace those new to "the tribe." Welcome aboard, new gun owners. We're glad you're here. 🍷



PISTOL FUNDAMENTALS TIPS TO KEEP YOU ON TARGET

A FOUNDATION FOR ADVANCED SKILLS REQUIRES SOLID BASICS. HERE ARE EIGHT FUNDAMENTAL TIPS TO GET YOU ON YOUR WAY TO SHOOTING SUCCESS.

■ ARTICLE AND PHOTO BY CHRIS MUDGETT

There are many people reading the *2021 GLOCK Annual* magazine who are brand new to firearm ownership and shooting. Welcome to those who are new. We want you to be safe and have fun with your new firearm, but getting there has a learning curve.

Safety is your first, last, and always priority when handling a firearm. These four safety rules must be front and center every time you handle a firearm:

- Treat every firearm as if it is loaded.
- Be sure of your target and what's beyond it.
- Keep your finger off the trigger until you are ready to shoot.
- Never point your gun at something you do not intend to destroy.

With those four rules in mind, it's time to build your skills and become proficient with your firearm, whether you're dry-fire practicing in the comfort of your home (no ammunition in your gun or in the room in which you're practicing) or shooting live rounds on the range. Here are tips to help you do just that.

- 1. Maintain a Balanced Stance**—A balanced, forward-leaning, stance is the foundation of consistent shooting. Your feet should be positioned approximately shoulder-width apart, with your non-firing foot a half step forward of your firing foot. This will support your natural point of aim. Your weight should be over your toes and balls of your feet, and your knees should be slightly bent. Ensure your upper body remains erect; your forward lean is accomplished with your lower body and knees. You should not be bending at the waist.
- 2. Proper Trigger-Hand Grip**—Wrap your strong hand as high on the grip of your pistol as possible, with no space between the web of your hand and the beavertail. Your grip should resemble a firm handshake.
- 3. Proper Support-Hand Grip**—The key to shooting multiple rounds quickly and accurately is an efficient support-hand grip. A neat trick to get this right: Extend both arms toward your target, strong hand holding your firearm while making a “finger gun” with your support hand. Point your support-hand “finger gun” at a 45-degree angle toward the ground, open that hand, and wrap it, like a clamshell, around your

firing-hand grip on the pistol. Do *not* change the angle of your support hand when you do this. The heel of your support hand should cover the exposed portion of your pistol grip, and your fingers should be as high beneath the trigger guard as possible. Your support-hand thumb should be pointed at the target, and your wrist should be nearly locked, relying on bone support instead of your tendons.

- 4. Drawing**—Draw your pistol from its holster in an upward motion. Once the gun clears the holster body, rotate the pistol's grip downward, leveling your barrel horizontally in the direction of your target. Begin pushing the pistol up and toward the target, and up into your line of sight like it's riding an escalator, not up toward your chest like an elevator and then out.
- 5. See Your Sights**—When your arms are fully extended in front of you with your pistol pointed toward the target, your sights should be utilized. *Always*. Line them up correctly and focus on the front sight.
- 6. Carry a Reload**—Always carry a spare loaded magazine. Many semiautomatic pistol malfunctions can be traced to the magazine, so out with the bad and in with the good. It's also not hard to see the advantages of having extra ammunition on-hand in certain situations.
- 7. Index Your Magazine**—When it's time to reload (and presuming you're wearing a magazine pouch on your belt), drop your support-hand palm onto the baseplate of your spare magazine. Extend your index finger along the front of the magazine (bullets should face your centerline when in a pouch or pocket), as you draw it up and out of its pouch. Whenever possible, your index fingertip should contact the exposed bullet at the top of the magazine as a tactile indicator that the magazine is, in fact, loaded.

You will learn dozens, even hundreds of other skills as you become comfortable with your gun, become confident in your ability to hit the target, take part in advanced instruction, and hopefully begin to explore the many shooting sports available. But, no matter where the road of firearm ownership takes you, safety and these eight fundamental tips are sure to help you enjoy the journey. ☉



Photo by Frank Steiger

WELCOME, NEW HANDGUN OWNERS!

IF YOU'RE ONE OF 2020'S MANY NEW HANDGUN OWNERS,
YOU CAME TO THE RIGHT PLACE.

■ ARTICLE BY MASSAD AYOUB

The first half of 2020 brought a brutal one-two punch that rocked millions of people into the awareness of a firearm's self- and family-protection attributes for the first time. The opening blow was the COVID-19 pandemic, when the nation's authorities and news media told the public that the disease would cripple law-enforcement response. In fact, at least one major police department reported itself 20-percent short on manpower due to officers sickened with the virus and coworkers they'd inadvertently exposed, all of whom had to quarantine. Then, just as states began to emerge from stay-at-home lockdown orders, public safety took another agonizing hit as violent rioting erupted across the country over controversial arrests and shootings by police. In Seattle, protesters were allowed to wall off several blocks and prevent police from assisting in emergencies, shootings, in-progress burglaries, and arson.

Like fire extinguishers used while waiting for the fire department and first aid kits to deploy until paramedics arrive, the responsibly and competently used defensive firearm is an emergency rescue tool with which to hold off death and crippling injury until the police can get to the scene. Or, if they can't get there at all.

Note that I said "responsibly and competently used" in speaking about a defensive firearm. Let's talk about that.

HELP IS AT THE TOUCH OF YOUR KEYBOARD

If you don't have someone in your circle already capable of teaching you, where do you turn? Millions of first-time firearm buyers during the 2020 pandemic had little access to training because, along with everything else going down, the COVID-19 quarantine closed many firing ranges and training academies, along with other schools in America. When that happened, those other learning institutions went online for first-time firearm-owner education.

Kathy Jackson's website, corneredcat.com, is a treasure trove of critical information for first-time firearm users, including the first thing they need to learn: gun safety. Any worthwhile instructor will impart the importance of the four primary rules of firearm safety first advanced in the mid-20th century by gun expert Col. Jeff Cooper. Paraphrased, they are:

1. Treat every firearm as if it is loaded and ready to fire.
2. Never let the muzzle cross or point at anything you do not intend to kill or destroy.
3. Keep your finger out of the trigger guard until you are in the act of intentionally firing the weapon.
4. Always be certain of your target and what's beyond it.

An internet search will reveal the retail gun shops and ranges in your area, most of which will be happy to furnish you with the contacts for local instructors. Many these days even have one or more instructors on staff. If not, the National Rifle Association is the leading source for firearm safety instructors, with tens of thousands certified. You can reach out to the organization at firearmtraining.nra.org/. Another alternative is to contact the local branch of your state's natural resources agency. These state agencies offer hunter safety courses in which most also teach firearm safety.

Comprehensive information on safety, including safe storage of firearms through its excellent Project ChildSafe and "Own it? Respect it. Secure it." initiatives, is available from the National Shooting Sports Foundation at nssf.org/safety/ and projectchildsafe.org

To learn how to safely handle your new gun, don't just scan the owner's manual that came with it. Carefully and thoroughly read *all* of it. (If you bought a used GLOCK without the owner's manual, visit us.glock.com/en/downloadable-materials.) If you've never handled any firearm at all, you'll want to learn about the basics of handling and safety through a certified instructor or other experienced shooter. If you have some familiarity with firearms and your owner's manual has given a leg up on a gun new to you, though, you'll want to experiment with the slide, magazine catch, and other functioning parts, but remember that you should not have any live ammunition in the same room with you during such exercises. That includes in the magazines. Unload *everything* and put the ammo in another room.

The most popular defensive handgun in America today is the semiautomatic pistol, and the most popular of those is the GLOCK. Now, some people have trouble drawing back the slide of a semiautomatic, a movement commonly called "racking." If this is a problem, I can confidently suggest two free online tutorials. One comes from the aforementioned Kathy Jackson. Though she's one of the best firearm and self-defense instructors around for students of all skill levels, she's particularly famous for her advice to women. Type "Racking the Slide" into the search bar on her corneredcat.com homepage to read her advice on performing this maneuver safely and effectively. A well-done video from the Warrior Poet Society on the same topic can be found by searching YouTube.

Paul Lathrop and his team at the Polite Society Podcast (named from sci-fi giant Robert Heinlein's popular phrase, "An armed society is a polite society"), marshaled a group of us who make our living teaching firearm use to contribute to his video series "GUNS 101." The tutorials, at politesocietypodcast.com, cover almost all of the many aspects a new firearm owner needs to grasp.

GLOCKTRAINING.COM

As you might imagine, there is no better place to learn everything about your new GLOCK than from the expert handlers behind the guns at GLOCK Professional Inc.

GLOCKTraining.com is your top resource for this. There are eight courses to choose from, ranging from the basic GLOCK Operator and GLOCK Low-Profile Carry courses to the more advanced classes that enable you to become a certified GLOCK instructor or armorer. You'll also find the training schedule for the year, with classes taking place all across the country, as well as links to the GLOCK Sport Shooting Foundation and one for ranges wanting to host GLOCK Professional Inc. training classes.

YOUR LEARNING CURRICULUM

Once you've learned how to safely load, unload, store, and fire your new handgun, you want to become skilled with it. A well-designed shooting class can save you years of frustration

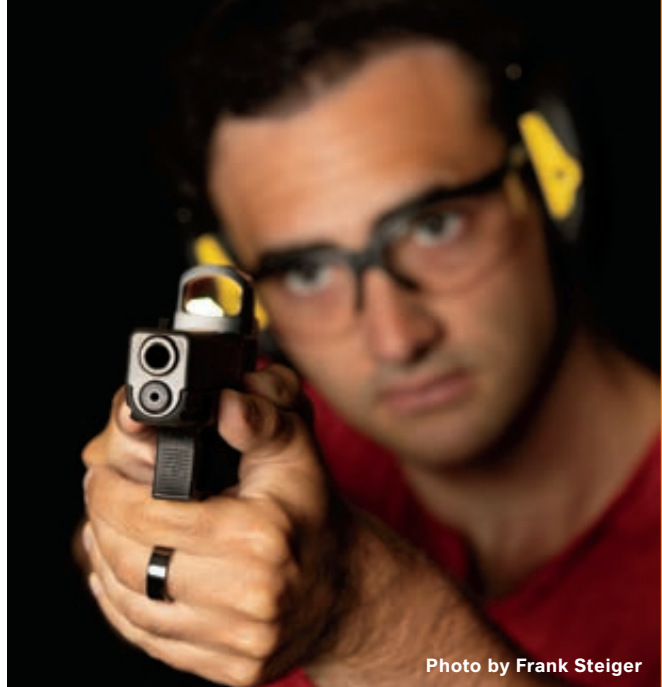

Photo by Frank Steiger

(and lots of money spent on ammunition), by keeping you from building a repertoire of bad habits. Your firearm safety instructor can usually offer skill-building shooting courses of their own, but if not, ask them to refer you to coaches who specialize in that. It does not matter if your goal is toward self-defense, competitive sport shooting, or simply the mastery of an iconic tool like the GLOCK, there's an instructor out there for it.

As your skill set increases, you may become interested in taking advanced training. There are many fine schools around the country worthy of a "destination trip." A compendium of these can be found at firearmtraininghub.com. GLOCKTraining.com's advanced GLOCK Modular Optic System Operator Course and Advanced Armorers Course will also be of interest to you. Before you invest in any training, though, some things to consider.

For defensive purposes, it's critical to not only know how to use your gun, but when. Start with some reading. Two books I strongly recommend are Andrew Branca's *Law of Self-Defense, Third Edition*, and my own book, *Deadly Force*. Both are available from Amazon. Both Branca and I teach classes on the topic around the country, and more information on what we do can be found, respectively, at lawofselfdefense.com and massadayoobgroup.com.

Self-defense laws and laws about gun ownership, storage, transportation, and carry are different things. The key elements allowing the use of a gun in self-defense are reasonably homogeneous state to state, but laws as to what guns, magazines, and ammo you can possess and carry, and where, are a 50-piece patchwork quilt. The best, most up-to-date resource I've found for these issues is the website handgunlaw.us. Gary Slider and his team there are in constant contact with state attorneys general to stay on top of ever-changing interstate concealed-carry license reciprocity and related matters.

BOTTOM LINE

A firearm is a lethal weapon. With the power it brings us to protect ourselves and our loved ones from violent crime comes the responsibility to handle it safely, as well as keep it secure and out of the hands of those who cannot be trusted with it. Once these things are learned, they confer an additional level of safety to self and family, but safety can never be taken for granted.

If you're one of our new firearms owners, welcome to the society of the responsibly armed. If you're an old hand, please do all you can to help new gun owners in your sphere to know all they need to become safe, responsible gun owners. ☺



Your hand is different than anyone else's hand. It's critical, for both safety and accuracy, that the gun you chose fits *you*. (And, thankfully, there's a GLOCK for that!)

FINDING THE PERFECT FIT

TALL OR SHORT, BIG OR SMALL—AND ESPECIALLY IF YOU'RE A WOMAN—GLOCK HAS A MODEL FOR EVERY INDIVIDUAL.

■ ARTICLE AND PHOTOS BY TATIANA WHITLOCK

A woman who has only ever worn sandals has just moved to an icy climate and needs to invest in appropriate footwear, but has no idea where to start. She walks into a fancy shoe store and nervously browses the well-lit display shelves.

Standing in the middle of the store, she takes in the hundreds of neatly arranged styles, every type of shoe from dress boots and sneakers to designer stilettos and flats. With so many choices, she is instantly overwhelmed. Relief appears to come when she's approached by a salesperson.

"I just need to buy shoes I can wear all the time," the woman says, explaining she's just moved from a warm-weather beach community. The salesperson walks her to a display case, saying, "Ma'am, being a woman and new to this area, what you need is something easy to wear and nothing too complicated. Here are all of my wooden shoes. They won't break, and you won't need shoe polish or have to tie the laces. You can't go wrong!"

Should the woman trust this sales pitch? Are wooden shoes the most responsible investment?

Both men and women tell similar stories about their first firearm purchase. The physical, technical, and ethical stakes, of course, are far higher with firearms than with shoes, and a one-size-fits-all approach, offered by far too many store clerks, is ineffective.

Finding the perfect fit in a handgun should be a unique experience for each shooter. A responsible salesperson and an educated consumer must know to ask questions about

need and application, take a few critical measurements, and understand physical limitations.

MOTIVATION MATTERS

Fitting a new buyer with a tool that could save their life is a heavy responsibility. The first step in this process for the person behind the counter is to discuss why a customer new to firearms is interested in buying a gun in the first place. "What's your goal?" is a fantastic question with which to begin. Are they interested in a handgun for home defense because they live in a high-crime area with a rise in home invasions, or are they seeking their first .22-caliber pistol for steel challenge competition at the local gun club?

At the onset of 2020, statistics from the National Rifle Association (NRA) showed 23 percent of women in the U.S. own guns, compared to 13 percent in 2005. Similarly, the National Shooting Sports Foundation (NSSF), the firearm industry trade association, documented a 77-percent rise in female gun ownership since 2005. That data is pre-COVID-19. Over 6.5 million firearms were sold in the first quarter of 2020 as the pandemic took hold. According to an NSSF May 2020 report, *First-Time Gun Buyers Survey During COVID-19*, 40 percent of first-time gun buyers were females who invested in semi-automatic handguns for self-defense. Those numbers are *staggering*, and with them comes the heavy responsibility of fitting all these new buyers with the tool that could save their life.

HAND GEOMETRY AND SIZE MATTER

An anthropometric analysis of static hand measurements conducted by NASA revealed that the average female hand has a length of 6.8 inches, a width of 3.1 inches, and a circumference of 7 inches. In comparison, men, on average, have close to a 1-inch larger hand length and circumference than do women.

While gender is not necessarily indicative of hand size, an individual's height does have a proportional relationship to their hand geometry. In other words, what works for the 6-foot 5-inch bodybuilder is going to be functionally different from what works for the 5-foot 2-inch ballerina.

The good news? GLOCK handguns accommodate the spectrum of user interfaces based on human-performance metrics and provide options for the individual. For instance, the majority of shooters possessing average hand measurements often find the globally popular GLOCK 19 in 9x19 a natural fit. Those individuals whose hands fall below average dimensions will likely prefer the single-stack GLOCK 48 in 9x19, with its Slimline frame and reduced trigger distance, as their "Goldilocks" gun. As for those whose hands are larger than the statistical average, a GLOCK 17, also in 9x19, will almost surely provide the balanced and reliable feel in their hands they seek.

SOLUTIONS FOR SOUTHPAW SHOOTERS

For decades, left-handed shooters have been shoehorned into handguns designed for the right-handed. While becoming an ambidextrous shooter is an important skill to develop, it is a less than optimal starting place for a new shooter. GLOCK's Gen5 series addresses the needs of the southpaw shooter, and in true GLOCK fashion provides several models for a perfect fit.

The GLOCK Gen4 handguns include a reversible magazine catch, while the GLOCK Gen5 models include both a reversible magazine catch and an ambidextrous slide-stop lever. By allowing left-handed shooters access to the controls on the right side of the handgun, those shooters can work with the firearm, without compromise, using the same techniques as their right-handed shooting partners.

CALIBER SELECTION

Caliber selection is an essential factor in pairing a new shooter with the correct handgun. Individuals with preexisting conditions or injuries to the hands, wrists, elbows, or shoulders have options from GLOCK that allow them to shoot with less or no pain. The GLOCK 44, for instance, is a G19-sized handgun chambered in .22 LR. It is remarkably soft-shooting. An ideal gun for those interested in "plinking," or casual target practice, the G44 also finds favor with more experienced shooters wishing to practice more but at a fraction of the cost of using centerfire ammunition.

For the nervous new shooter, the G44 helps eliminate the fear of recoil and aids in learning safe gun handling. For those looking for a next step up in calibers, GLOCK has more than 50 models spanning .380 AUTO, 9x19, .357 AUTO, .40 AUTO, .45 AUTO, .45 G.A.P., and 10mm AUTO.

GRIP STRENGTH

When it comes to felt recoil, a person's grip strength plays a significant role in managing the gun safely and consistently. *The International Journal of Industrial Ergonomics* published a study by Yong-Ku Kong and Brian D. Lowe in 2005 that tested maximum grip force for handtools. The study found a direct relationship between handle diameter and the user's perceived comfort and finger and phalange force distribution. Yong-Ku and Lowe's results concluded that the optimal handle diameter is 19.7 percent of the user's hand length. No need to pull out

a calculator! GLOCK Gen4 and Gen5 handguns adapt to nearly every hand size, allowing the user to maximize their grip strength, with the GLOCK Modular Back Strap System.

Once a shooter has made their caliber and model selection, they can fine-tune their handgun to the perfect grip by using the different backstraps supplied with the pistol. One backstrap is intended for a medium grip size, adding $\frac{8}{100}$ of an inch from the back of the grip to the trigger, while the second, which adds $\frac{16}{100}$ of an inch, is for larger grips. This small change to a GLOCK's grip can increase ergonomics and maximize a shooter's grip strength without having to hit the gym or hire a gunsmith.



A gun too large may have you struggling to reach the trigger. One too small and you'll overreach it. Try as many GLOCKS as you can in the caliber you desire and you'll quickly discover the best fit.

VISION

As we age, aligning and focusing on traditional iron sights can become quite a challenge. Electronic reflex sights, or red-dot sights, have become a new standard in defensive handguns for users of all ages and abilities, and they offer a fantastic solution for those experiencing vision changes. To make adding such an optic to a handgun easier, GLOCK designed the Modular Optic System (MOS). GLOCK MOS models come equipped with a slide cut and a collection of interchangeable mounting plates that fit reflex sights from various manufacturers.

TEST DRIVE

Determining gun fit goes beyond how the gun feels in your hand. It is also predicated on the shooter's ability to consistently manipulate the handgun without struggle, compromised form, or frustration. The best way to ensure a shooter and the gun are a match made in heaven is to test-drive the equipment with both dry-fire (no ammunition in the gun or in the room or area in which you're performing this exercise) and live-fire practice.

A recommended dry-fire practice could entail performing, with dummy rounds, the load and make-ready procedure, presentation to the target, sight picture and alignment, and a clean trigger press followed by locking the slide back and unloading the gun of all dummy rounds. Assuming correct techniques are employed, this simple exercise illuminates any user-interface issues such as reach to the trigger, single- or double-stack grip width preferences, and sight selection. After comparing a few models via dry-fire, follow a similar course of action at the range with live-fire to confirm and hone in on the best option.

Thanks to manufacturers like GLOCK, new shooters have a wide range of solutions to meet their unique needs and interests. Rather than taking someone else's word for it, buyers should seek out retail venues with range access and classes that include a variety of GLOCK models to try, so that they can easily learn what works and what doesn't. For those in the business of selling handguns, examining the physical human factors unique to each shooter and pairing them with the appropriate firearm features makes finding the right gun for the customer easier and avoids a regretful "wooden shoes" purchase. ☉

Your storage options are as varied as your choice of handguns. Hornady's RAPID Safe, pictured here, is an ideal single-handgun storage unit for most small to mid-sized handguns, and some full sized handguns will fit just fine, too. Visit Hornadysecurity.com to learn more. (Photo By Frank Steiger)



SAFE FIREARM STORAGE EVERY GUN OWNER'S FIRST RESPONSIBILITY

**YOU'VE LEARNED THE RULES OF SAFE FIREARM HANDLING.
HERE'S HOW TO KEEP YOUR GUNS SAFE WHEN YOU'RE NOT ON THE RANGE.**

■ ARTICLE BY CHRIS EGER

One of the most important responsibilities a gun owner has is to ensure their firearms are safely secured when not in use. In a different era, “hiding” a gun on a high closet shelf, in a desk drawer, or (yikes!) between a mattress and box spring were common choices. Then or now, *none* are safe choices. Small, curious children, even toddlers, can discover them. Criminals know to look in those places, just as do youths and teens who haven't been taught better and are looking to show off dad's gun to friends. We've all seen the headlines that result from these things—and it would be a great thing to never see again.

Complete gun safety today includes a plan for securing your gun or guns when not in use. That plan means different things to different people. If you keep a loaded firearm for self-defense in your home, for instance, you'll want to access it quickly if needed. You might also want another trusted person

in the household to have access, but not children or snooping visitors. Those needs will require a different locking solution than the guns of, say, a collector. In either case, and in every other situation imaginable, educating those in your household about firearm safety and how the firearms in your house are secured (though that doesn't necessarily mean granting access to everyone in the home) is mandatory. It's not a one-size-fits-all fix. Choose the solution that works for you.

THE WIDE, WIDE WORLD OF FIREARM STORAGE

Now it's time to take a look at some of the many options available to today's firearm owners. They range from simple, single-gun lockboxes with physical keys or a padlock and more advanced units with advanced biometric and pattern locks to closet-sized uprights and floor models that take a piano mover to install.

Costs, like options, greatly vary. Some considerations include:

- A few dollars for a cable lock that prevents an action from closing or a trigger from being operated.
- A couple hundred dollars for:
 - An unadorned upright safe, suitable for holding a half-dozen long guns and a couple handguns and often available from big-box “Mart” stores. They usually have a simple combination lock and can sometimes be bolted to the floors or walls of a closet. (Any time you can make it harder for a thief to do their “job,” the better.)
 - Single-handgun safes for nightstand or other home area use, with biometric or fast-actuation keypad combination access.
- Several thousand dollars for heavy (as in hundreds of pounds) free-standing units that are fire-resistant for extended periods and include all sorts of extras like built-in humidifiers, movement monitoring, handgun racks, and more. They will hold dozens of firearms and can be designed to accommodate specific needs like, say, the person who has 57 GLOCKS and nothing else. Some companies can even install armored bank vault-type doors to make an entire room your gun safe.



One of the biggest advantages of a standing floor safe like this one from Cannon is its weight. It takes a very determined criminal to make off with it.

TRADITIONAL CHOICES

Cannon Safe—Founded in 1965, this company sells a variety of home and office safes, including the electronic keypad-equipped Landmark series that uses 4-inch locking bolts in its doors. These are perfect for tight spaces, such as apartments, closets, and underneath desks. (cannonsafe.com)

Fort Knox Gun Safes—Taking its name from the U.S. Army post in Kentucky protecting our country’s gold reserves, Fort Knox Gun Safes offers everything from vault-room doors to secure shelving and everything in between. It has dozens of options that cater to pistol owners, including a line of carpet-lined pistol boxes, big enough for a handgun and extra magazines, that have 10-gauge steel bodies, mechanical locks, and $\frac{3}{16}$ -inch door plates. (ftknox.com)

Hornady Manufacturing Co.—Best known for its ammunition, Hornady also offers the ingenious RAPID Safes, which use an RFID wristband, key fob, or decal to unlock the units. Their spring-assisted lids make them an ideal choice when seconds count. (hornadysecurity.com)

Liberty Safes—One of the country’s largest safe manufacturers, Liberty markets a line of handgun vaults that include fifth-generation biometric finger-swipe technology that can accommodate up to 15 different fingerprints. (libertysafe.com)

Pendleton Safes—The discerning handgun collector will give a nod to Pendleton’s made-to-order storage solutions that incorporate a bright-white LED-lit interior, built-in moisture control, and Revolution Technology, Pendleton’s motorized rotating shelf design that maximizes interior space. (pendletonsafes.com)

SnapSafe—The Dropbox from SnapSafe is constructed of 16-gauge steel and features a programmable keypad code. It can be mounted under a counter or desk and even on the side of a nightstand. (snapsafe.com)

UNCONVENTIONAL SOLUTIONS

American Furniture Classics—This company produces a line of wood-and-metal furniture pieces that pull double-duty by incorporating unexpected storage options. If you like the finer things in life, the locking coffee table gun rack made from beautiful solid acacia wood is a head-turner. (americanfurnitureclassics.com)

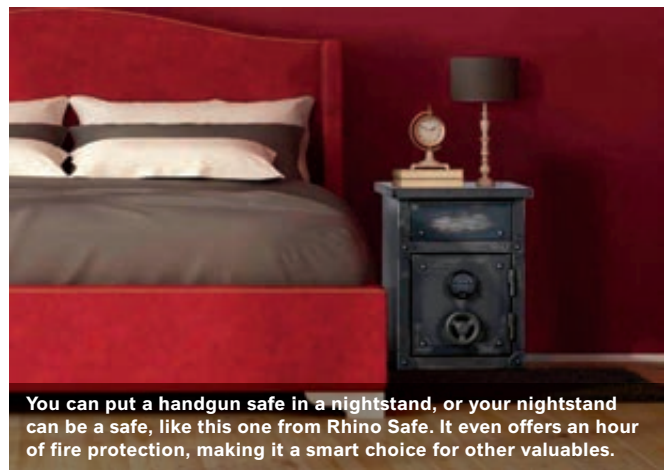

You can put a handgun safe in a nightstand, or your nightstand can be a safe, like this one from Rhino Safe. It even offers an hour of fire protection, making it a smart choice for other valuables.

BedSafe—This company has several creative, quick-access (or at least relatively quick) storage options, including a dual-sided BedBunker that replaces a box spring. The CouchBunker works like a sleeper sofa, but with a gun vault instead of a mattress inside. Check out the built-in floor and wall options, too, and designs for vehicle storage. (bedsafe.com)

Rhino Safe—This company crafts a line of furniture that includes armoires, bars, and credenzas. One example is the Longhorn Security Safe, a fire-rated, 150-pound nightstand with 14-gauge steel construction, anti-punch and anti-drill bolt works, an electric lock, and a handgun holder secured in the drawer back. (rhinosafe.com)

ON THE ROAD

Stuffing a handgun in the console between the seats, pushing it under a seat, or placing it in an easily defeated glove box are *not* safe storage choices. Guns left in such locations can be stolen by entry-level thieves, and “shoving” a gun into anything that’s not a holster designed to protect the trigger should *never* be an option. The best way to store a firearm in a vehicle is in a locking device securely affixed to metal framing. I mentioned the vehicle options from BedSafe, above. Here are several others to consider.

Console Vault—Offering a range of in-vehicle safes made for specific car, truck, and SUV models, Console Vault storage options install in just 10 to 15 minutes, come in a choice of three drill-resistant lock types, and are made of heavy-gauge, cold-rolled plate steel. (consolevault.com)



The Console Vault (above) is an intelligent choice for those who travel with a handgun and need to safely secure it in their vehicle. It installs in under 15 minutes. The Liberty HD-90 safe (below) can be attached to a secure point in your vehicle via its heavy-gauge security cable. It's 18-gauge steel construction is also a theft deterrent.

Hornady—A mobile take on the RAPID home model mentioned before, the RAPiD Vehicle Safe features a streamlined storage configuration and can be powered via 12-volt adaptor or with AAA batteries. A security cable rated for 1,200-pounds ensures the safe stays put. Unlock the cable and the user can relocate the safe to a hotel room or other lodging. (hornadysecurity.com)



Liberty Safe—The HD-90 safe is an economical solution to portable firearm storage needs. It is light at 5.1-pounds but has 18-gauge steel construction—take that, thieves! With an efficient barrel lock and a security cable, this pistol safe can be used in hard-to-access areas. (libertysafe.com)

Winner International (a.k.a. The Club)—Yes, *that* The Club, the famous steering-wheel locking device. The company that owns also makes The Club Personal Vault, designed to fit under most vehicle seats and secured with a braided-steel cable. (winner-int.com)

TAKING TO THE AIR

With some exceptions for approved law enforcement, the Transportation Security Administration (TSA) and airlines operating in the U.S.—regulations covering international travel with firearms would need an article all its own—prohibit firearms, firearm magazines, and small-arms ammunition aboard a plane in carry-on baggage. Those items must be transported in checked baggage, firearms and magazines unloaded and locked in a hard-sided container. Also, per the TSA's online regs regarding travel with ammunition:

- Small arms ammunition (up to .75-caliber and shotgun shells of any gauge) must be packaged in a fiber (such as cardboard), wood, plastic, or metal box specifically designed to carry ammunition and declared to your airline.
- Ammunition may be transported in the same hard-sided, locked case as a firearm if it has been packed as described above.

When you arrive at the airport, you must declare to your airline's desk agent that you're traveling with a firearm. Your baggage will be inspected by a TSA agent before you head to the gate-area check-in line to ensure the gun is unloaded and secured per all regulations. You will then lock your firearm/ammunition cases and turn your luggage over to TSA for the rest of its inspections. Storage solutions with key or combination padlocks or biometric or keypad combinations are key to getting through this process efficiently. Be sure to check with TSA (tsa.gov) and your airline for additional information *before* arriving at any airport with a firearm or ammunition.

Here are a few recommendations for people traveling from sea to shining sea with their handguns.

Pelican—Well-regarded for its watertight equipment cases that feature a solid-wall design and a reputation for being crushproof, Pelican also makes an array of handgun cases. Secured with twin padlocks, they are a smart choice for air travelers. (pelican.com)

Bulldog—With a double-molded outer shell of an ABS polycarbonate and secured with a combination lock, Bulldog's Pistol Case is affordable, holds up to four handguns, and includes a TSA-approved combination lock. (bulldogcases.com)

SnapSafe—Weighing just four pounds and using a mechanical lock, the SnapSafe Lock Box, in three sizes, includes a 1,500-pound-rated steel cable that can be attached to the primary luggage bag's frame. ☉

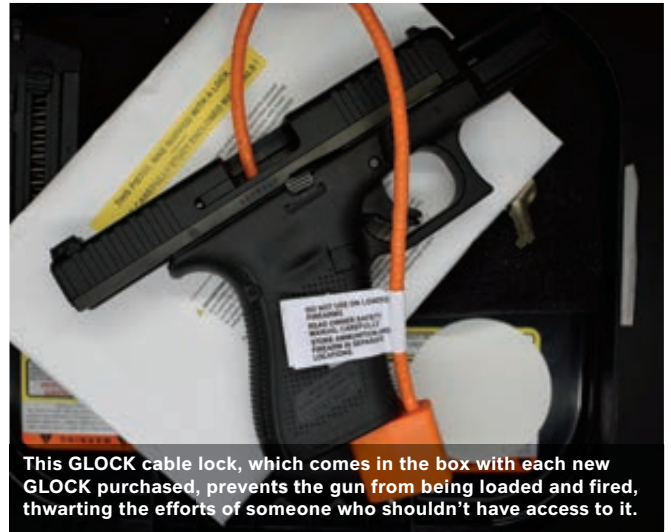

This GLOCK cable lock, which comes in the box with each new GLOCK purchased, prevents the gun from being loaded and fired, thwarting the efforts of someone who shouldn't have access to it.

ADDITIONAL SAFETY RESOURCES

GLOCK—For additional guidance on firearm safety, go to [us.GLOCK.com](https://us.glock.com) and tap the "LEARN" menu at the top of the page for information on three safety topics: "All About Ammo," "All About Pistols," and "S.A.F.E."—Serious About Firearms Education. There's also a "Firearm Legal Information" page any GLOCK owner will find useful. Under the "Own" tab at [us.GLOCK.com](https://us.glock.com), the selection "Storing Your GLOCK" hosts a video about safe storage responsibility.

Project ChildSafe—A nationwide initiative created by NSSF, the trade association for the firearm industry, Project ChildSafe provides gun owners with numerous resources and information about responsible firearm storage. The initiative works with law enforcement across the country to distribute safety locks. Visit projectchildsafe.org to learn how to obtain a free safety kit and gun lock.

GLOCK SAFETY KNOWLEDGE

While some GLOCK models can be ordered with a factory-installed internal locking device, all GLOCK handguns sold in the U.S. and Canada include a free cable lock with two keys. To use on an unloaded pistol without the magazine in place, lock the slide back, insert the opened cable through the ejection port and out the bottom of the magazine well, then lock it into place. As with any keyed firearm lock, store the keys separately from your pistol.



WE HAVE YOUR SIX: GLOCK'S CONTINUING LAW ENFORCEMENT LEGACY

FOR MORE THAN THREE DECADES, GLOCK HAS SWORN TO SERVE AND PROTECT THOSE WHO HAVE SWORN TO SERVE AND PROTECT ALL OTHERS.

■ ARTICLE BY MIKE MCALLISTER

In 1986, GLOCK came to the U.S. with a mission to provide our country's law enforcement with the very best. After 34 years of service, GLOCK has done just that—GLOCK pistols are carried by more than 70 percent of law enforcement in the United States.

IT'S PERSONAL

When words like “reliability,” “dependability,” and “accuracy” are talked about in professional law-enforcement circles, it is clear that GLOCK continues to deliver year after year, decade after decade, meeting the high standards demanded by those who've sworn to protect. Many companies would rest on their laurels when they've had success like this, but GLOCK doesn't. It continually seeks to improve its firearms because the people behind the brand, the majority of which have law-enforcement or military backgrounds, understand the sacrifices made by law enforcement and their families. For those employees, there is a personal satisfaction and pride that comes with being part of a company that delivers the very best to our nation's protectors.

AROUND-THE-CLOCK SUPPORT—IT MATTERS

GLOCK manufactures nearly all pistol parts in house. GLOCK in-house manufacturing ensures every step in creating its pistols is synonymous with perfection. That includes ensuring law enforcement agencies and staff have access

to factory assistance 24/7, 365 days a year, with employees trained to handle and trouble-shoot questions and issues onsite. When a phone call or an email isn't enough, an officer or agency will be face to face with a GLOCK armorer within 24 hours. That's the service our first responders deserve.

GLOCK supports law enforcement in a variety of ways. In the fall of 2020, GLOCK hosted a law-enforcement appreciation day in which officers and their families gathered to sample all the new GLOCK models. They also enjoyed fun shooting competitions alongside the professional competitors of Team GLOCK, and GLOCK armorers were onsite to answer questions and provide a safe and educational shooting environment.

GLOCK also offers special pricing to our first-responder and law-enforcement professionals through its Blue Label Program. The Blue Label program allows first responders to make two GLOCK purchases per year at a discounted price. For those departments that provide a small uniform allowance each year to their officers to purchase their duty firearms, GLOCK additionally extends special pricing for those agency professionals.

GLOCK HAS YOUR SIX

GLOCK extends its sincere thanks to everyone who has defended the thin blue line. To those who have given the ultimate sacrifice, we will never forget you. To those now serving, we will always be by your side, we will always have your six. Stay safe. ☉



The first and sometimes only tool for self-defense is each deputy's duty pistol, as seen here with Officers Josh Calderon (kneeling) and Travis Thornton.

ALABAMA'S CALHOUN COUNTY IS GLOCK COUNTRY

A SHERIFF'S OFFICE MAINTAINS OLD-WORLD SOUTHERN HOSPITALITY IN THE FACE OF MODERN PROBLEMS WITH GUNS THEY'VE TRUSTED FOR 25 YEARS.

■ **ARTICLE AND PHOTOS BY ANDRE' M. DALL'AU**

Several years ago, Jimmy Woodard walked into his friend's business and almost immediately felt the people there were acting oddly. The vibes were off. It didn't take long to find out why. The robber Woodard had just interrupted panicked and began to run out of the store, raising his weapon as he ran, at point-blank range, right at Woodard.

Woodard instinctively turned at the sudden motion and found himself looking down the barrel of a .45 AUTO as it erupted in flame and noise, giving him a nanosecond to respond.

You might expect a tragic outcome from such a telling. But that wasn't to be, because what the bad guy didn't know was that not only was Jimmy Woodard an off-duty Deputy Sheriff for Calhoun County, Alabama, he was armed with a GLOCK.

ONCE A MILITARY TOWN, CHANGE BRINGS CHALLENGES

Calhoun County, Alabama, is in the Choccolocco foothills of the Appalachian Mountains. The county seat is Anniston. During the Spanish-American War, the U.S. Army established

temporary Camp Shipp nearby; Anniston was on the path of a north-south railroad track that continued to Mobile, a major Gulf seaport for Cuba-bound logistics. During World War I, Camp Shipp, now called Camp McClellan and, later, Fort McClellan, was one of 32 mobilization bases that supplied soldiers for the American Expeditionary Force. In WWII, it grew to be one of the largest U.S. Army installations, training an estimated half-million troops and housing German and Italian P.O.W.s. Nearby was the Anniston Army Airfield (now Talladega Superspeedway), which supplied basic pilot instruction in BT-13 trainer aircraft and advanced training in B-24s and B-29s.

When Fort McClellan closed in 1999, the base employed about 10,000 military personnel (half of whom were permanently assigned) and nearly 1,500 civilians. The closure and the attendant loss of facilities, jobs, and commercial businesses that supported the base resulted in what is still an ongoing stress to the community and law enforcement.

Calhoun County, as so many do, deals with the problems of illegal drug manufacture and use. The additional criminality those activities foster include property crimes and violence

“Every GLOCK operates the same and has a consistent trigger pull, making it easier to use. No matter which GLOCK you pick up, you know how to shoot it.”

against both citizens and law enforcement. Sheriff Matthew Wade and the Calhoun County Sheriff's Office deputies and investigators ensure that the over 100,000 residents and a similar number of daily visitors are safe and can enjoy true Southern hospitality. To help carry out their protection and leadership duties for the community, one of the tools they choose is their GLOCK duty pistol.

DODGING A BULLET—LITERALLY

As Jimmy Woodard miraculously managed to dodge the bad guy's fire, he pulled his own life-saving tool, his issue GLOCK 22 .40 AUTO pistol, firing almost a half-dozen shots and driving his assailant out onto the street. The injured criminal was later taken into custody after he fled the scene and attempted another robbery.

Now a Calhoun County Sheriff's Office Investigator, Woodard is proud of his justifiable affinity for his issued and self-purchased GLOCKS for both on- and off-duty protection. He notes that they have saved his life not only during that encounter in his friend's store, but several other times as well.

THE AGENCY BEHIND—AND STANDING BEHIND—GLOCK

The ability to instantaneously deliver life-saving protection is founded in the confidence in the reliability of his GLOCK wrought by both the harsh realities of sudden gunfights and the grind and wear of daily use. Woodard told me, “In Alabama, we can go from sunny days with high humidity to soaking rain, and we get involved in a lot of pursuits on roads, off roads, and through the woods. We frequently get into manhunt situations through the many creeks and swamps we have, and we constantly get wet with our GLOCKS. But, regardless of the conditions, we know they will always perform, because water or even fouling with mud is never a problem with our GLOCKS when it comes to delivering protection for our deputies and citizens.”

There are more than 50 sworn Calhoun County Sheriff's Office investigators, school resource officers, patrol officers, courthouse personnel, and reserve deputies issued and trained on the powerful G22. One of the youngest investigators is Mason Love, who is also an M.P. in the National Guard and a dedicated GLOCK enthusiast. “It fits comfortably in my hand, and I know it will always perform, so I am a GLOCK fan!” he said with enthusiasm, adding, “Besides my duty G22, I have a GLOCK 19 and my own G22. My grandfather shoots a GLOCK, and I got my personal GLOCK from my dad, so GLOCK runs in the family.”

First sworn in in 1996 and sheriff since 2016, Matthew Wade has been serving Calhoun County for a quarter century, and all that time with GLOCK pistols. “We have never carried anything else! I like them all,” he said. Wade emphasized why the legendary GLOCK simplicity and reliability is so important, saying, “We have to teach a lot of young deputies who have not shot before, but we instruct them on how to shoot the GLOCK, and they have high scores. Our G22 is a very effective and reliable tool.

“When you get in a high-stress situation—like when one guy shot at us at least 42 times—I want a gun that, when I pull it out, it's going to work!” he added. “Every GLOCK operates the



Exercising their GLOCKS at the range are, left to right, Investigators Mason Love, Josh Calderon, Jimmy Woodard, Jameson Trammell, and Range Officer Pat Medders.

same and has a consistent trigger pull, making it easier to use, and because they have a standard design that is comfortable and familiar, no matter which GLOCK you pick up, you know how to shoot it.”

Sheriff Wade's commitment to proper gun use and safety is another reason he's dedicated to GLOCK. “For 25 years, the Calhoun County Sheriff's Office has been teaching a free civilian firearm safety class quarterly, with a classroom session and then range time to get people trained and comfortable with their firearms. Usually, 30 to 50 people show up, but our biggest had more than 400 people attending!”

Wade emphasized that GLOCK has been, is, and will be the only duty weapon that Calhoun County Sheriff's Deputies carry. “I don't want to carry anything else. We found a GLOCK that had been lost for about three weeks on a dirt road, and all it had was a spot of rust on the barrel. It still worked great. Plain and simple, they work. You can carry it, abuse it, and, when you want to use it, it works every time.”

Those sentiments are echoed by Woodard. As a Calhoun County Sheriff's Office GLOCK-trained and -certified advanced armorer, Woodard is ready to address repairs or adjustments on his department's GLOCK pistols anytime, anywhere. Even on the tailgate of his truck. With his battery of well-used and personalized GLOCK pistols, Woodard is convinced by years of experience that GLOCK pistols are not only the most reliable, but the easiest on which to work.

“I like to keep things simple, and the GLOCK is *amazingly* simple. I can quickly go through a GLOCK and inspect and diagnose it—although it is rare I find anything wrong—and I then replace parts, which is super-easy.”

When asked about the responsiveness and effectiveness of GLOCK's customer service, Woodard expressed a common sentiment, saying, “Although I haven't had any instances of needing immediate assistance, I know that I can make one phone call and GLOCK will solve any problem.” ☺



The Calhoun County Sheriff's Office elite Investigative Unit is tasked with the apprehension of felons and the serving of warrants. GLOCK 22 pistols serves as these officers' duty weapons.



SCOTT COUNTY SHERIFF'S OFFICE A DECADE OF TRUSTING IN GLOCK

WHEN THE TIME CAME FOR THIS SUBURBAN MINNESOTA LAW ENFORCEMENT AGENCY TO CONSOLIDATE ITS CHOICE OF FIREARMS AND CALIBERS, GOING GLOCK PROVED TO BE A DECISION OF LASTING IMPACT.

■ ARTICLE BY SEAN CURTIS ■ PHOTOS COURTESY OF SCOTT COUNTY SHERIFF'S OFFICE

America's law-enforcement ranks are filled with proud traditions and a rich culture you'd expect from a profession that's been around for almost 200 years. However, that culture doesn't always include standardization. American law-enforcement differs from the military in that way, and benefits to the individual deputies have, with some frequency, outweighed the desire for uniformity over the decades. Since 2010, Minnesota's Scott County Sheriff's Office has been challenging that idea because the agency found a solution that worked better for everyone—GLOCK.

The Scott County Sheriff's Office (SCSO), located 25 miles southwest of Minneapolis, serves around 150,000 residents. Deputies have a roughly 365-square-mile response area that is largely suburban and rural agricultural in nature. Abundant recreational locations dot the landscape, a haven for outdoor enthusiasts. The law enforcement mission of the SCSO is to provide primary response in unincorporated areas, as well as support to the many municipality police agencies scattered throughout the county. It accomplishes this with a dedicated force of 57 sworn deputies and total personnel running to more than 160.

After nearly a decade with G17 and G19 Gen4s, the SCSO took the opportunity in 2019 to upgrade to Gen5 technology. Deputies immediately realized the benefits of a red-dot sight.

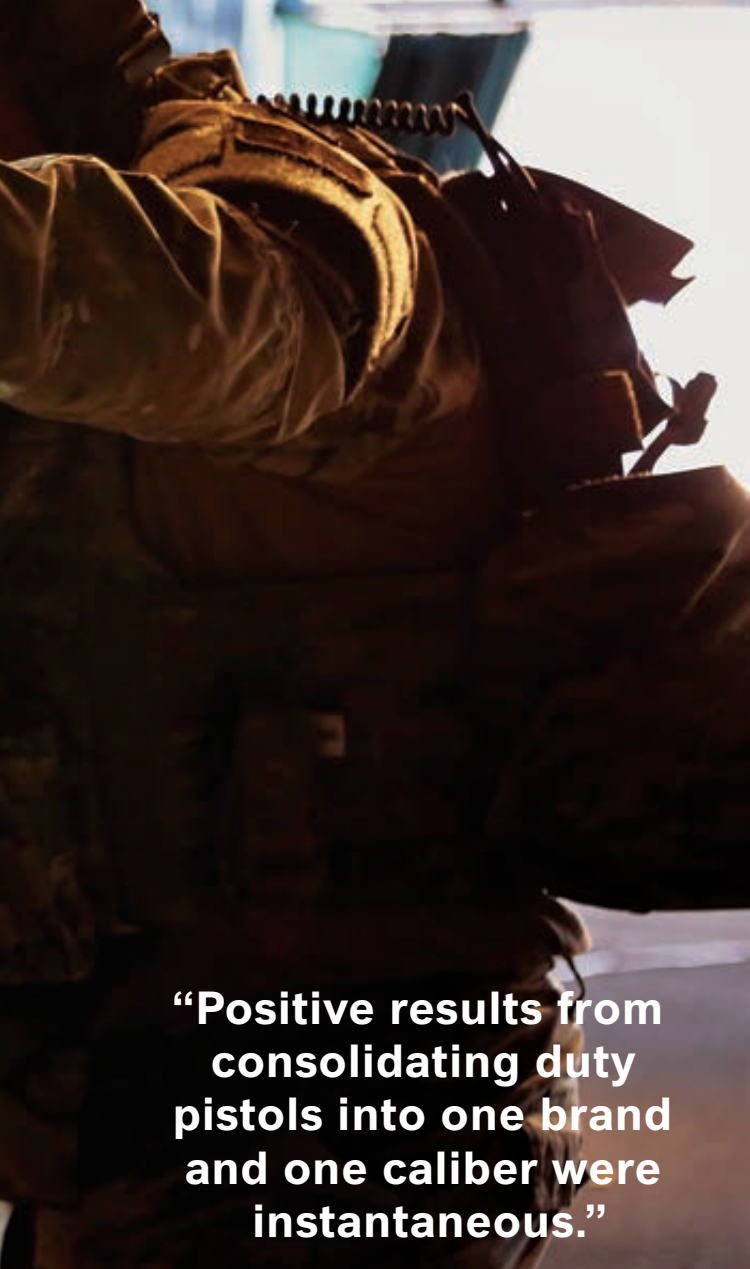

“Positive results from consolidating duty pistols into one brand and one caliber were instantaneous.”

SEEDS OF CHANGE

Until 2010, the SCSO had a wide-open policy, when it came to firearms. That’s when someone came along and suggested some uniformity.

Deputy Todd Beck came to Scott County from a California law-enforcement agency and the United States Marine Corps before that. He was accustomed to uniformity and suggested that concept to his fellow firearm instructors after seeing some training and qualification difficulties with the agency’s deputies. At the time, SCSO deputies carried a variety of firearms diverse in both manufacturer and caliber. Beck approached the agency’s captain and said he felt like they could save a lot of money and hardship by standardizing their pistols.

The idea took root, and in 2010, the Sheriff at the time agreed to testing several models from different manufacturers. The agency assembled an evaluation team that conducted range trial days and participant surveys. At the end of the process, the GLOCK 17 Gen4 and GLOCK 19 Gen4 carried the day.



The Scott County Sheriff's Office encourages its deputies to add a weapon light to their duty GLOCKS and take advantage of advanced training offered by the agency.

Beck said the competition wasn’t even close. Even deputies who had reservations about changing firearms were impressed with the way everyone was able to pick up a GLOCK and shoot well with it.

COMING OUT ON TOP

After the results were in, the Sheriff authorized the agency to convert to GLOCK in 2011. Beck told me they purchased 60 GLOCKS, with a breakdown of approximately 40 G17s and 20 G19s. The agency also bought several GLOCK 43s for its Drug Task Force Agents.

Positive results from consolidating duty pistols into one brand and one caliber were instantaneous. With uniform equipment, sergeants had an easier time issuing firearms and holsters to deputies. Armorers were also able to focus on one make of firearm instead of having to service numerous different weapon systems. But, one of the most appreciated benefits of the consolidation was seen in the Sheriff’s Office firearm instructors having more time to train shooters: Without the jumble of models and calibers to deal with, they could now focus on developing critical, life-saving skills.

There was another plus: Because each gun had a GLOCK mounting rail system, deputies were encouraged to add a weapon light to their GLOCKS and improve their tactical skills, with Beck adding that the agency had begun low-light scenario training. Beck also noted that the SCSO sent a number of employees to the GLOCK Armorer’s course. Once certified, those employees created a program in which every gun gets a complete inspection each November.



Scott County Sheriff's Office deputies now carry two of the most advanced handguns in the world and take full advantage of their technology with the addition of on-board lights and red-dot optics.

The acquisition process went extremely well, according to Beck, who said the Gen4 GLOCKS ran great for the next eight years. In 2019, the SCSO started looking at replacing night sights and magazines. Beck said he saw that, with trade-in value, the newer Gen5 GLOCKS were within budget and suggested to Captain Steve Collins the agency make the move. While the transition was under consideration, Collins learned of the Gen5 MOS option and added that to his proposal to the Sheriff, who ultimately approved the purchase.

STAYING ON TOP

The SCSO received its new GLOCKS in March 2020, right around the beginning of the Coronavirus pandemic. Over the next two months, Beck told me, the agency qualified 57 deputies on the new GLOCK G17 and G19 MOS Gen5 models, though qualification was more challenging because many deputies were unfamiliar with the new technology and instructors were having to process one shooter at a time because of pandemic social-distancing restrictions. As tough

as that was, the agency saw an enormous benefit in getting deputies to shoot with both eyes open and maintaining target focus (as opposed to front-sight focus), thanks to the addition of red-dot optics. According to Beck, most shooters took just nine to 15 rounds of practice before they'd start punching the same hole over and over at 15 yards. He said that once the deputies became accustomed to the new technology, they were "dead on."

Ten years ago, the Scott County Sheriff's Office firearm qualifications were complicated by different gun models in different calibers. Leadership proved willing to consider a better way, and the agency, through testing, found GLOCK outperformed all other options. When it was time to upgrade again, the longevity of those first GLOCKS had proven itself, and once again GLOCK was the choice. Today, the SCSO's deputies venture forth with the most advanced handguns in the world. That choice, just as is the choice of so many others, is testament to the innovation, durability, and ruggedness that is the legacy of the GLOCK brand. 🍷



Minnesota is known for its harsh winters, but that doesn't dissuade people from pursuing outdoor pursuits year round. Carrying GLOCK helps SCSO deputies meet the demands of such active residents.



They don't call Minnesota "The Land of 10,000 Lakes" for nothing. SCSO deputies have duties on and off dry land, and they trust GLOCK's reliability across the spectrum of environments.



Many of New Jersey's East Brunswick Police Department officers had been requesting a transition to GLOCK when the agency made the decision to begin an upgrade to its handguns in 2017. Though the process took a while, they got their wish.

NEW JERSEY'S EAST BRUNSWICK POLICE UPGRADE TO GLOCK 45 AND GLOCK 43X 9X19s

A SMALL SUBURBAN COMMUNITY WITH A THRIVING RETAIL DISTRICT NEEDS LAW ENFORCEMENT OFFICERS WHO UNDERSTANDS ITS NEEDS. THOSE OFFICERS NOW MEET THOSE NEEDS WITH GLOCK AT THEIR SIDES.

■ ARTICLE BY SEAN CURTIS ■ PHOTOS COURTESY OF EAST BRUNSWICK POLICE DEPARTMENT

Just 40 miles southwest of the Statue of Liberty lies the city of East Brunswick, New Jersey. Within its 22.5 square miles, there are roughly 50,000 residents in need of law enforcement services. The East Brunswick Police Department (EBPD) answers that call with 83 sworn officers and eight part-time special police officers, four of which are armed. At the helm, Chief

Frank LoSacco is steering his organization into the second decade of the 2000s. I spoke with him about his agency's transition to GLOCK.

The chief said his department serves a heavy retail corridor along Route 18, and that landscape generates a lot of calls. He also noted the suburban aspect of the community, saying that a percentage of the department's work revolves around domestic



East Brunswick's close proximity to New York City means the city incurs some of the Big Apple's criminal element. The city's police department is better prepared to handle those challenges with its recent upgrade to GLOCK.

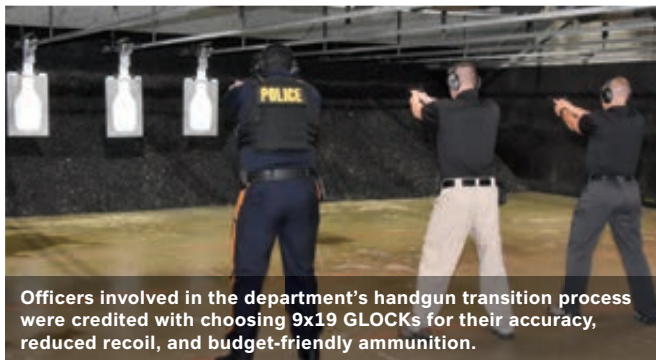

Officers involved in the department's handgun transition process were credited with choosing 9x19 GLOCKS for their accuracy, reduced recoil, and budget-friendly ammunition.

“When the time came to test the G45, officers say their shot groups were noticeably tighter, and many described a feeling of needing less effort to control the gun.”

violence cases and traffic enforcement. Overall, the department is divided into three different divisions: Operations; consisting of Patrol and Special Operations (predominantly Traffic Safety and S.W.A.T.); Investigations, with a Detective Bureau, Bureau of Criminal Identification, and a Juvenile Unit that includes school resource officers; and Administration, which oversees budgeting, human resources, fleet maintenance, and the East Brunswick Police Department Training Facility.

The department's building has a 50-seat classroom and a 12-port indoor firearm range, along with a PRISim shooting

simulator. This state-of-the-art facility is extremely important to the EBPD and also serves to boost regional law enforcement training, as the EBPD rents it out to other municipal, state, and federal law-enforcement agencies for their use.

Chief LoSacco has been with the agency for 24 years. He took over as chief on July 31, 2019, and has navigated a number of departmental changes since then, including the switch to GLOCK. He said much of the legwork regarding the decision had been completed before he was sworn in, but he performed a final review to ensure everything about the decision was right for the department. In his review, the chief



credited other officers for their input about the accuracy of the 9x19 round and the additional capacity afforded by GLOCK pistols in that round. In addition, he noted economic incentives in making the move to GLOCK.

MANAGING CHANGE

The EBPD started its process of changing firearms and caliber in May 2017. At the time, many officers were requesting a shift to GLOCK; approximately 80 percent of the agency's officers were already carrying GLOCKS off-duty. The agency obtained several GLOCK 17 and GLOCK 19 pistols for testing and evaluation, first by a group of firearm instructors, then with officers pulled from the field. Feedback was gathered, and when it was all said and done, the G17 had won the day.

The win was temporary. As the EBPD was testing its GLOCKS, GLOCK released its new GLOCK 19X, and officers took a keen interest in that model. Next came the GLOCK 45 release, and that model too joined the testing panel of the EBPD—and the officers *loved* them. They appreciated the grip and frame as well as the shorter slide, all of which combined to make felt recoil much more manageable. Shot groups were noticeably tighter, and officers described a feeling of needing less effort to control the gun. Another feature they appreciated was the same smooth trigger pull every time they fired the gun, a significant change from the double-action/single-action design of their previous sidearms. Finally, the weight savings the transition to G45 afforded the officers was much applauded.

MOVING INTO THE FUTURE

Final approval to obtain the agency's new GLOCKS was received in March 2020. While the firearms had not yet been received at the time this *GLOCK Annual* went to press, the department purchased 108 G45 and 10 GLOCK 43X models. The G45 will fill the role of the main sidearm for most units, while the G43X will optionally serve detectives, plainclothes officers, and administrators. EBPD also plans to have a few G45s converted for use in its PRISim simulator, adding a level of realism officers have not previously experienced in their training.

Switching an entire police agency over to a different caliber and manufacturer is no light decision to make, but the groundwork and testing completed by the firearm instructors and officers of the East Brunswick Police Department made the decision easier for Chief LoSacco. Indeed, with GLOCK at their sides, the future looks bright for this forward-thinking agency of community protectors. ☺



New Jersey's East Brunswick Police Department have acquired the GLOCK 45 for most officers and the GLOCK 43X for detectives, plainclothes officers, and administrators.

GLOCK IS THE GO-TO CHOICE FOR POLICE OF THE LONE STAR STATE

SECOND ONLY TO ALASKA IN SIZE AND EVERY BIT AS WILD, TEXAS PRESENTS MYRIAD CHALLENGES TO LAW ENFORCEMENT ACROSS THE STATE—AND THEY MEET THEM HEAD-ON WITH GLOCK.

■ ARTICLE BY CHRIS EGER

From the high-rise cities of Dallas and Fort Worth and thousand-acre cattle and quarter-horse ranches to sprawling suburbs, backwater towns and undulating miles of mesquite-covered hills, law enforcement in the Lone Star State increasingly trust GLOCK pistols

to help them protect their streets and citizens. With that trend comes two others: The 9x19 replacing guns chambered in .40 AUTO, and officers upgrading their duty guns with red-dot sights. Here's a look at how GLOCK is making the grade with police officers of all missions across this sprawling Southwest state.



From left to right: Houston Police Academy cadets engaging in close-quarters accuracy drills with their GLOCK 17 Gen5 MOS pistols (Photo courtesy of Houston P.D.); A Missouri City Police Department officer working through a weak-side single-handed drill with his GLOCK (Photo courtesy of Missouri City P.D.); An officer with the Pasadena Police Department puts his GLOCK through its paces during a barrier drill (Photos courtesy of Pasadena P.D.).



TEXAS



TOP: Houston Police Academy cadets go through rigorous training with their GLOCK 17s. (Photo courtesy of Houston P.D.)



RIGHT: The value of a GLOCK with a red-dot optic is quickly realized in close-quarters drills. (Photo courtesy of Houston P.D.)

HOUSTON

Serving the fourth-largest city in the U.S., the Houston Police Department (HPD) has more than 5,200 sworn law enforcement officers. The esteemed agency dates to 1841, to the days when it was the Republic of Texas. Over most of its modern history, HPD has required its officers to provide their own duty weapons, allowing them to choose from a list of three approved firearms. That resulted in a host of legacy platforms—a few veteran officers even still carried revolvers—but that all changed under the direction of Chief Art Acevedo.

“Any new hire who comes through and joins the Houston Police Department and goes to the Police Academy can purchase only a GLOCK 17 Gen5 MOS,” said Officer Robert Walsh, HPD’s Firearms Training Coordinator. As the agency also moves to include a red-dot sight as standard carry equipment, having the universal mounting plate on the G17 Gen5 MOS fit the agency’s choice of red-dot sight without gunsmithing was key with administrators who worried that new-hire cadets wouldn’t get their guns back in time for scheduled training if they had to have them milled aftermarket.

While the easy installation of a red-dot was a big factor in the choice of the G17 MOS, Houston’s officers had long been fans of GLOCK, with as much as 70 percent of the department carrying one model or another of the iconic handguns—voting with their own money, you could say.

The shift to the G17, of course, means the agency’s officers are now carrying guns chambered in 9x19. That’s a significant change, as new hires had been restricted to pistols in .40 AUTO.

“Terminal ballistics of the 9x19 have come a lot further over the last couple of years. It’s a lot better round than it used to be,” said Walsh. “It offers a few more rounds in the magazine, and a little less recoil for our smaller-statured officers so they can manage it better, especially in multiple-shot and movement drills.”

With the consolidation to a single platform, Walsh says training has gone smoother as instructors no longer have to invest extra time in teaching firearm manipulation, maintenance, and nomenclature for three different firearms. Too, the red-dots have been a big improvement for the agency in improved accuracy and the ability to pick up a sight picture sooner than with a traditional iron sight. Walsh commented, “The red-dots have allowed us to move up our qualification test day sooner, because our recruits are better sooner.”

This has allowed instructors to cover additional shooting techniques, some of which they’d rarely had a chance to impart to new hires, in the same time it used to take just to cover the basics. This advanced training includes simulated injured-shooter drills, shooting with movement, shooting from additional positions and vehicles, and off-duty plainclothes concealment classes. All this is, without a doubt, value-added for the largest municipal police department in Texas.



Instructors with the Missouri City Police Department saw a 20-percent decrease in qualification failures when they acquired their latest GLOCKS. (Photo courtesy of Missouri City P.D.)

MISSOURI CITY

Nicknamed “The Show Me City,” Missouri City is in Eastern Texas, across Fort Bend and Harris counties. In serving a population of about 75,000, the 100-strong Missouri City Police Department (MCPD) does superb work for its community, earning the city the honor of being named one of the top 10 safest cities in the state.

MCPD has been a GLOCK-issuing agency since the early 1990s. Prior to that, officers could carry what they chose, with departmental approval. The change worked well for MCPD, and when it came time to update its sidearms again in 2018, the agency stayed with GLOCK, moving from GLOCK 22 .40 AUTO and 23 models to G17 and G19 9x19 models.

The change in caliber came after the agency consulted with neighboring departments that had made similar moves. The final litmus test was to take officers who had a history of struggling to qualify on the range with their .40s and have them shoot the 9x19 GLOCK models. It was an experiment that yielded solid improvement, and today, the entire department carries either the G17 or G19 Gen5, with undercover officers using the subcompact GLOCK 26 or the GLOCK 43, and S.W.A.T. team members holstering the advanced GLOCK 34, a model that’s a favorite of both tactical teams and IPSC competitors nationwide.



Texas' Pasadena Police Department has long trusted its officers' lives to GLOCK. Here, officers are working on real-world street training scenarios. (Photo courtesy of Pasadena P.D.)



Officers with the Pasadena Police Department carry a variety of 9x19 GLOCK models. (Photo courtesy of Pasadena P.D.)

"Since changing to the current GLOCKS, we have seen an approximate 20-percent decrease in failures at qualification time," said Lance Bothell, Assistant Police Chief. "Our officers have said they're much easier guns to shoot due to less recoil. Accuracy overall has improved as well."

Located within an hour's drive of Texas' Gulf Coast beaches, humidity and high temperatures are a fact of life in Missouri City. However, the city has found its GLOCKS have withstood the harsh environment over the years.

"We, as an agency, have had very few issues with the GLOCKS we issue," said Bothell. "Our firearm instructors, who are also GLOCK armorers, rarely have to fix a GLOCK due to broken parts.

"We are extremely satisfied with the GLOCK handguns," he continued. "For the price and overall ease of maintenance, it is something we will stay with into the foreseeable future."

PASADENA

Known to many as "The Birthplace of Texas," due to its proximity to the San Jacinto battleground, Pasadena is a bustling modern city of 150,000 people. That populace is protected by the Pasadena Police Department (PPD), a 260-officer agency that has long trusted GLOCK.

"Our cadet class in 2004 was required to carry a G17 or G19. Prior to that class, cadets were allowed to carry a variety of weapon systems, but most did carry a GLOCK," said Officer Mike Huffman, Pasadena PD's Rangemaster. "The decision to go to a G17 or G19 was due to several reasons: GLOCK provided a weapon system that was easy to operate and learn to shoot on, was low in maintenance, and was extremely durable and reliable."

For a while, the department allowed the use of various GLOCK models in a range of calibers. Today, however, Pasadena's men and women in blue still supply their own sidearms but must choose from an approved list of 9x19 GLOCKS, specifically the G17, G19, and GLOCK 45, a change that took place early in 2020. While the first two models have always been a top choice with the agency's officers, the G45 has grown in popularity, as have MOS variants that support red-dot optics. Plainclothes units can also carry the more compact GLOCK 43X and GLOCK 48.

"We found that those cadets who were carrying a .40 AUTO or .45 AUTO tended to have more difficulty learning to shoot," said Huffman. "Grip size and recoil seemed to be the two major factors preventing new shooters from succeeding with our program. With the reduced recoil and improvements in cartridges over the years, the 9x19 has been an outstanding choice for us. The commonality in training and equipment was also a big factor."

Pasadena, like so much of Texas in the Gulf Coast region, has high humidity. Huffman told me that, in the past, he's seen rusting duty weapons from other manufacturers because they weren't corrosion-resistant. He noted that the GLOCKS used by the agency have not had the same problem.

"I have been the Rangemaster since 1994 and have seen the evolution of GLOCK over the years," said Huffman. "We are completely satisfied with their performance, and they will continue to be used based on their reliability and performance." ☉

We would like to thank Primary Arms, GLOCK's Texas law enforcement distributor, for its kind assistance with this article.

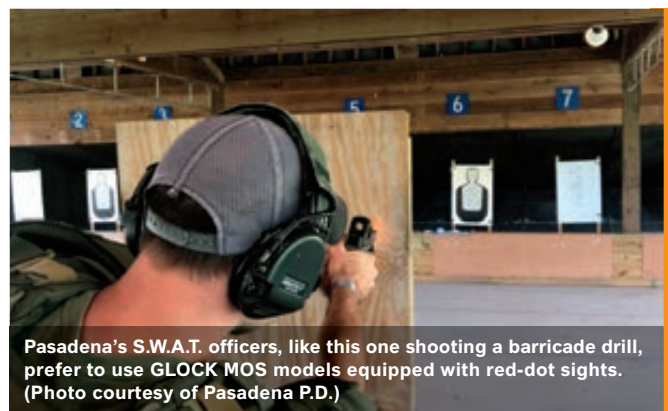

Pasadena's S.W.A.T. officers, like this one shooting a barricade drill, prefer to use GLOCK MOS models equipped with red-dot sights. (Photo courtesy of Pasadena P.D.)

Officers of the Pennsylvania Capitol Police take pride in their jobs, and that pride gets a boost with their new GLOCK 17 Gen5 sidearms that bear their agency insignia engraved on the top of the slide.

PENNSYLVANIA'S CAPITOL POLICE SWITCH TO GLOCK

EASE OF USE? CHECK. RELIABLE AND DURABLE? WITHOUT A DOUBT. IS IT A GUN THAT WILL ACTUALLY HAVE YOUR OFFICERS THANKING YOU FOR IT? WHEN IT'S A GLOCK, YOU BET IT IS.

■ ARTICLE BY SEAN CURTIS ■ PHOTOS COURTESY OF PENNSYLVANIA CAPITOL POLICE

Pennsylvania's state capitol is Harrisburg, a sprawling hub of activity protected by the Pennsylvania Capitol Police (PACP). At the agency's head is Superintendent Joseph Jacob. He's worked in a variety of roles over the course of a long and distinguished career in law enforcement, and he fully understands that the decisions he makes in his current position affect officers of all duty levels. It was with such understanding that he assembled a committee to investigate moving to a new weapons system.

The PACP is a rather unique law-enforcement agency when compared to municipal entities. The primary focus of the day shift, for instance, is on the security of the buildings and personnel in the capitol complex. Officers screen five main entry points, scanning some 250,000 visitors a year for signs of potential trouble and providing assistance when needed. Another task these officers handle is traffic duty, directing the comings and goings of more than 20,000 state employees on the capitol campus daily.

Jacob explained that the agency's jurisdiction is within Harrisburg city limits and that it enjoys a good working relationship with the local Harrisburg Police Department. PACP's solid reputation is backed by certification on the national level through the Commission on Accreditation for Law Enforcement Agencies (CALEA), and on the state level by the Pennsylvania Law Enforcement Accreditation Commission (PLEAC). The second-largest law-enforcement agency in the county, PACP has its own Special Response Team (SRT), Bicycle Unit, and a Field Force Unit that responds to civil-disorder incidents.



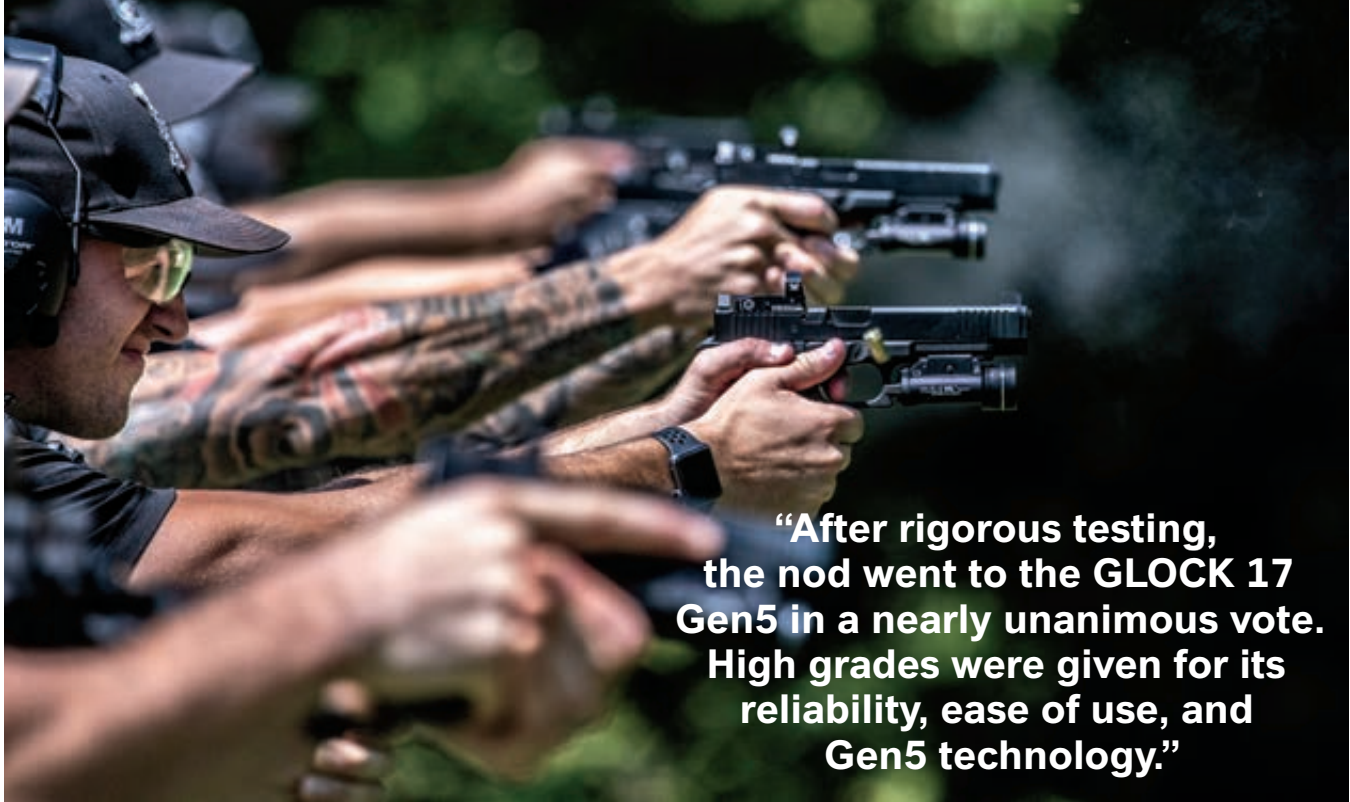

“After rigorous testing, the nod went to the GLOCK 17 Gen5 in a nearly unanimous vote. High grades were given for its reliability, ease of use, and Gen5 technology.”

CHANGING FIREARMS AND CALIBERS

The PACP had been using a firearm chambered in .45 AUTO for roughly a decade. Jacob had been a close study of caliber and the duty-gun trends in law enforcement—not just in recent history, but for the *past 47 years*—so when it was proposed that it was time for his agency to make a change, he assembled a committee of senior firearm instructors to start the process. They discussed several brands and models, ultimately obtaining samples from four manufacturers in July 2019. The work of live-fire evaluation was then turned over to a lieutenant and five instructors.

When the rigorous testing was completed, the nod went to the GLOCK 17 Gen5 in a nearly unanimous vote. High grades were given for its reliability, ease of use, and Gen5 technology. The head of the PACP also noted the committee found the sights were extremely easy to use and that the trigger was especially smooth.

Jacob quickly moved to the procurement phase of the process. With 110 sworn officers, transitioning everyone wouldn't be an overnight job. In addition to the new guns, all new holsters and magazine pouches were needed, so the call for bids was issued for them. The PACP also purchased 10 Simunition conversion kits to aid its officers in transitioning to their new firearm technology. Jacob also told me that the agency committed to have its patch insignia engraved on each

pistol. It's a classy move and one that instills a measure of pride in officers, often encouraging them to train harder and step up their maintenance protocols.

BUZZER BEATER

The PACP received its new GLOCKS in January 2020 and was able to qualify all but a few administrative personnel before COVID-19 restrictions radically changed how just about anyone in any job went about daily life. That the agency was able to complete the vast majority of its transition so quickly, Jacob said, attests to the ease of use for which GLOCK is famous. Jacob even emphasized that he's received nothing but thanks and compliments for making the change, particularly from younger officers. He said his staff “just love it” and are comfortable and confident carrying the new GLOCKS. The feedback was so positive, Jacob said, he also believed the positive handling experience with their GLOCKS would likely encourage them to shoot more than minimum requirements.

With the backing of two GLOCK Certified Armors on staff should a problem arise, the Pennsylvania Capitol Police begin a new era with one of the most reputable and reliable handguns ever made. The force looks forward to many years of service with its G17 Gen5s—and it already knows that when the time for the next upgrade arrives, GLOCK will be the one to beat. 🟡

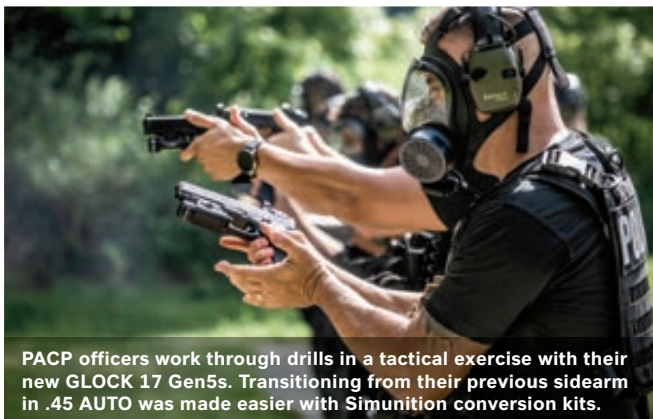

PACP officers work through drills in a tactical exercise with their new GLOCK 17 Gen5s. Transitioning from their previous sidearm in .45 AUTO was made easier with Simunition conversion kits.



An instructor with the PACP evaluates targets after a training exercise. Officers have expressed their thanks to the agency for making the change to GLOCK and improving their duty equipment.

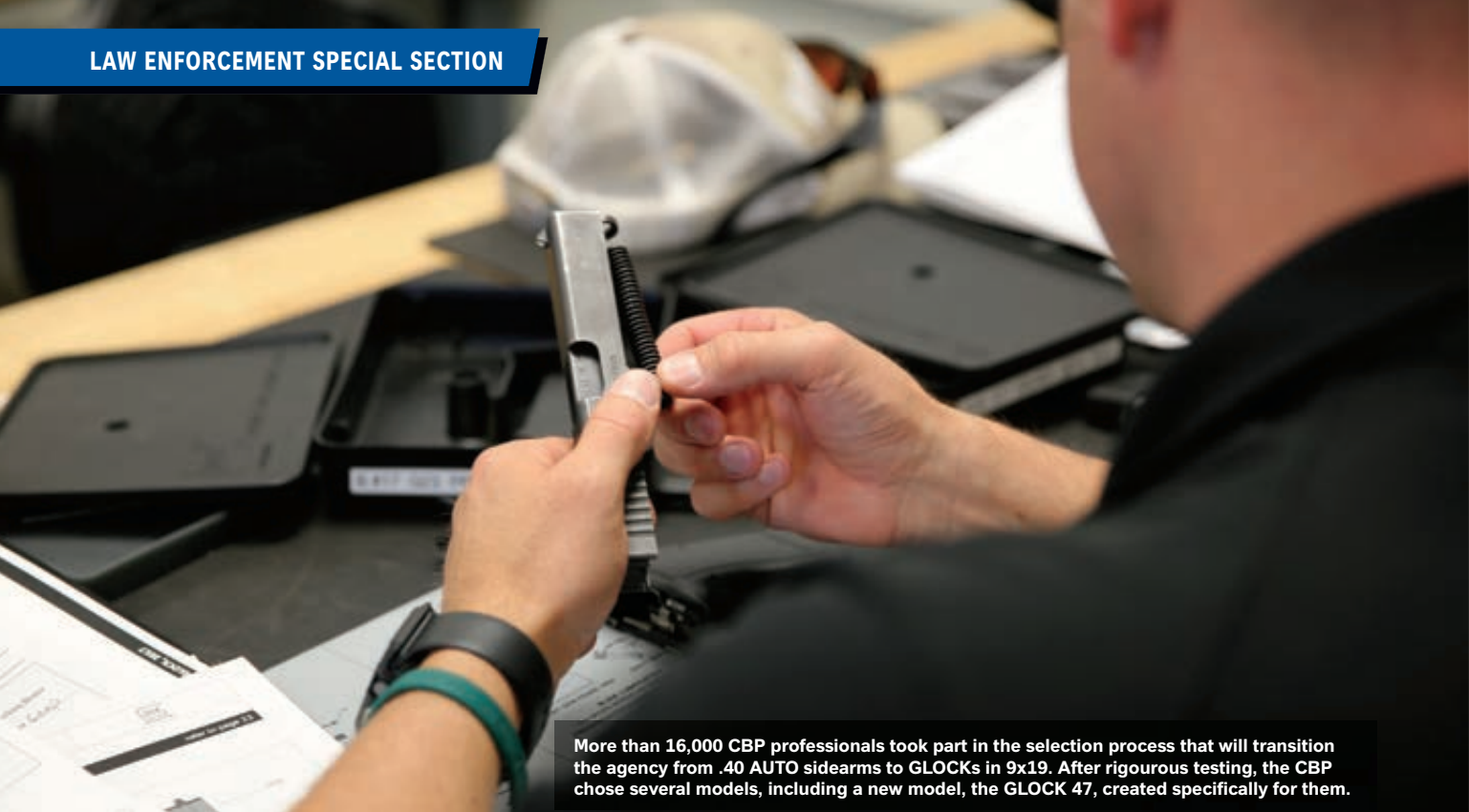

More than 16,000 CBP professionals took part in the selection process that will transition the agency from .40 AUTO sidearms to GLOCKS in 9x19. After rigorous testing, the CBP chose several models, including a new model, the GLOCK 47, created specifically for them.

U.S. CUSTOMS AND BORDER PROTECTION FIELDS GLOCK TO PROTECT HOMELAND

AMERICA'S PREEMINENT LAW ENFORCEMENT AGENCY CHARGED WITH PROTECTING OUR CITIZENS FROM COAST TO COAST AND AROUND THE WORLD TRUSTS GLOCK TO KEEP US SAFE.

■ ARTICLE BY CHRIS EGER

Our country's first border-security agency, U.S. Customs and Border Protection (CBP), is one of the largest law-enforcement agencies in the world. It is charged with the herculean task of protecting America's boundaries and ports of entry. To support this mission, one that requires the efforts of more than 61,000 men and women, CBP recently signed a historic contract to field GLOCK pistols.

THE AWARD

In April 2019, following an extensive review and solicitation process conducted by CBP's Law Enforcement Safety and Compliance Directorate, the CBP announced a 10-year award to GLOCK to replace the agency's legacy .40 AUTO handguns with several new 9x19 variants meant to accommodate every imaginable duty scenario.

"[This change to GLOCK] represents our commitment to providing the highest-quality use-of-force tools and equipment to our law-enforcement personnel who defend America's front line every day," said CBP Deputy Commissioner Robert E. Perez in a statement.

The grueling process that led to GLOCK's selection included field evaluations and input from more than 16,000 of CBP's law-enforcement staff, as well as testing conducted by National Institute of Justice independent laboratories.

Customs and Border Protection has a sweeping mission. On the average day, CBP processes more than a million vehicle passengers and pedestrians, along with \$7.3 billion worth of imported goods, through 328 ports of entry. More than 1,700 CBP staff work overseas in the same capacity, and more than 130 U.S. Border Patrol stations are manned as part of the effort to stop inadmissible persons and illicit goods at

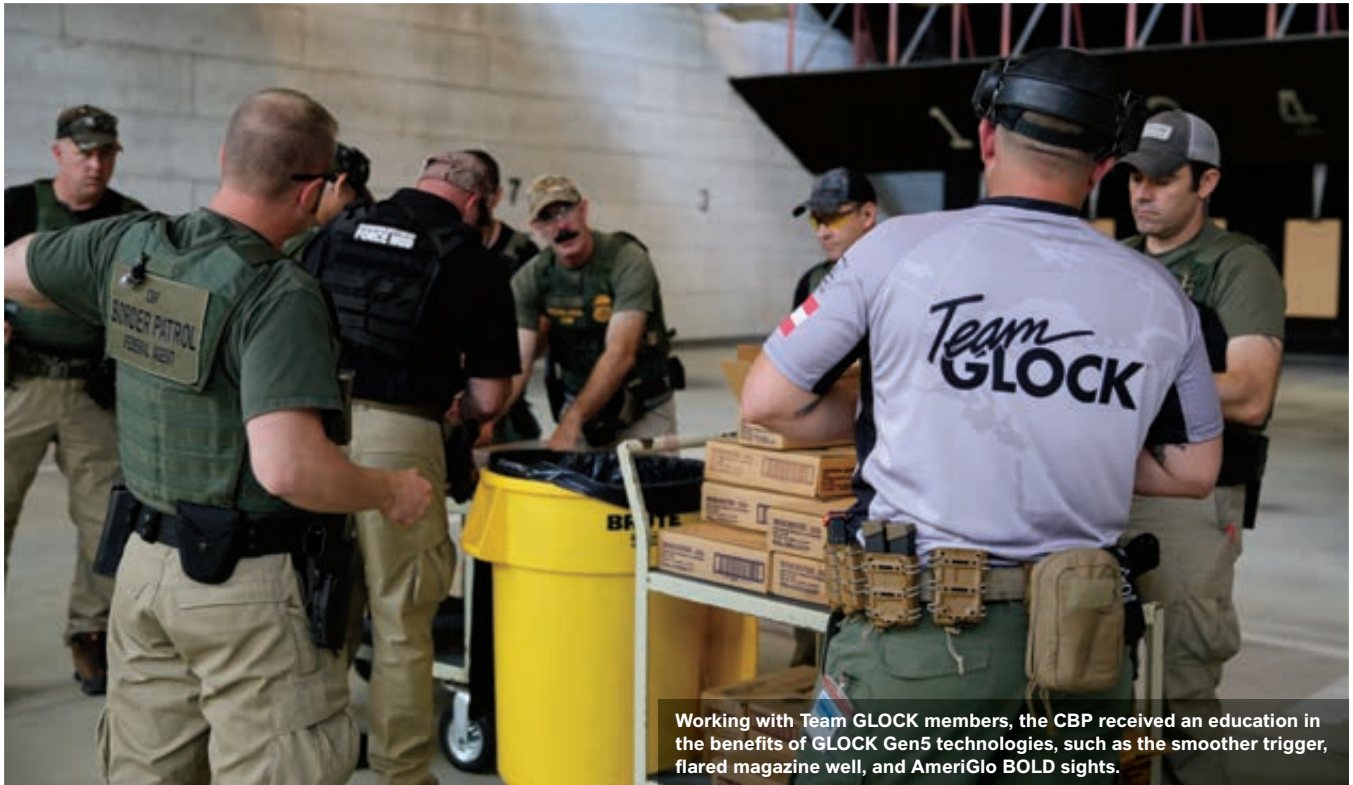

Working with Team GLOCK members, the CBP received an education in the benefits of GLOCK Gen5 technologies, such as the smoother trigger, flared magazine well, and AmeriGlo BOLD sights.

our borders; on average, 23 wanted criminals are taken into custody every day. In addition, CBP utilizes over 600 air and marine agents at 74 locations.

THE GUNS

In arming CBP with its next generation of duty handguns, the contract award covered several of GLOCK's most advanced 9x19 models and even included one new pistol explicitly developed for this agency. The new gun, the GLOCK 47, continues the iconic firearm maker's Crossover family, blending aspects of established pistols in the GLOCK catalog to produce a task-specific model. The GLOCK 47 employs a full-size GLOCK 17-length slide with a GLOCK 45 standard frame. The G45, first introduced in 2018 at the International Association of Chiefs of Police (IACP) Conference, typically uses a GLOCK 19 compact-length slide.

The G45 is one of GLOCK's Gen5 pistols that introduced upgraded features such as a smoother trigger pull, an enhanced frame texture, a reversible magazine catch, and an ambidextrous slide-stop lever. Also new on the Gen5 models are the accurate, match-grade, GLOCK Marksman Barrel (GMB) and front slide serrations.

In addition to the GLOCK 47, which will not be available on the consumer market at this time, the CBP contract includes the compact G19 Gen5 MOS and subcompact GLOCK 26 Gen5 models. All will be delivered with a flared magazine well, a feature ideal for faster magazine changes, and AmeriGlo BOLD day/night sights, which have a bright-orange outline with a Swiss-made green tritium insert.

"It is indeed a great honor to serve those who go in harm's way to protect all Americans and defend our borders every day," said Josh Dorsey, Vice President of GLOCK, Inc. "The comprehensive and arduous testing and evaluation process demonstrates that GLOCK pistols continue to deliver unmatched performance and value, giving all agents the confidence they need to succeed and survive in any situation."

CBP is set to transition to the new GLOCKS by the end of Fiscal Year 2021.

OTHER AGENCIES

The CBP contract, worth up to \$85 million, includes the option for other agencies under the Department of Homeland Security (DHS) umbrella to obtain the same firearms. As DHS has approximately 72,000 armed officers and agents across organizations such as the U.S. Secret Service, the Federal Protective Service, and the U.S. Coast Guard, the new contract presents an open opportunity for those agencies to also acquire GLOCK's latest handgun technology without having to enter into redundant agreements. Best yet, the prices to the CBP are frozen, a big benefit to the taxpayer and one that makes this contract a win-win for both Uncle Sam and the public. ☺



Switching to GLOCKS chambered in 9x19, easier to shoot than the agency's previous firearms in .40 AUTO, will greatly benefit the more than 61,000 professionals of the CBP.

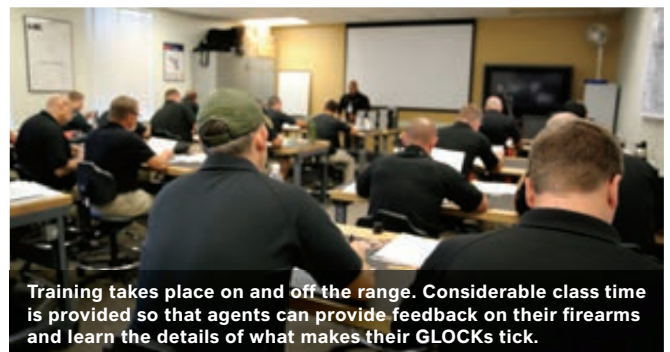

Training takes place on and off the range. Considerable class time is provided so that agents can provide feedback on their firearms and learn the details of what makes their GLOCKS tick.



HCSO Deputies Jimmy Cook (standing rear) and William Irwin (kneeling front) thoroughly appreciate the increased level of protection afforded by their new GLOCK pistols.

THE GLOCK 45s OF TAMPA BAY

**A METROPOLIS RENOWNED FOR ITS DEVOTED SPORTS FANS
AND BEACH-GOERS HAS LAW ENFORCEMENT PROTECTING ALL
WITH GLOCK'S INNOVATIVE CROSSOVER.**

■ ARTICLE AND PHOTOS BY ANDRE' M. DALL'AU

Encompassing Tampa and most of Tampa Bay, Hillsborough County dominates Florida with its sprawl and diversity. Second in population only to the greater Miami/Broward areas, Hillsborough County has every climatic, cultural, and environmental challenge to deal with, as well as the constant threat of hurricanes during broiling hot summers where the central Florida humidity alone wilts people and destroys equipment. For these reasons, among others, the Hillsborough County Sheriff's Office (HCSO) deputies recently adopted one of the most reliable service pistols ever known to American law enforcement, the GLOCK 45 9x19 pistol.

Developed with input from operators, civilians, and competitive shooters, and using engineering developed for its military pistols, the G45 is a crossover design bearing the textured, easy-to-grip full-size frame of a GLOCK 17 with the shorter GLOCK 19 slide and forward slide serrations. It has GLOCK Gen5 technologies, including a smoother, crisper, short-reset trigger, the more accurate GLOCK Marksmanship Barrel (GMB), an ambidextrous slide-stop lever, a reversible magazine catch, and GLOCK's Modular Back Strap System.

“The GLOCK is an incredibly durable weapon. It's my top choice for a duty weapon.”

TRANSITION AND TRAINING MADE EASY

While its S.W.A.T. team is issued the G21 and the G43 is issued for undercover work, since 2018, the G45 has been the duty weapon of choice for the majority of HCSO sworn personnel. More than 1,600 G45s have been assigned to the agency's patrol officers, detention officers, and even reserve deputies.

The responsibilities for distributing, training on, and maintaining this vast inventory of pistols fall to the instructors and armorer of the Training Division. Sergeant Matt Luckey is a 23-year police veteran who has served in specialized units such as the Street Crimes unit and the Homeland Security Special Incident Management Section. A veteran of the streets serving as a patrol officer and an alternate for the motorcycle unit, today he is in charge of the massive HCSO range facility that every deputy periodically attends for scheduled in-service



Hillsborough County Sheriff's Office GLOCK Certified Armorer Kim Stroud was a long-time gunsmith and champion competitive shooter before she joined HCSO. She is a big fan of her agency's GLOCKS.



The HCSO has an effective air unit that can be used for deployment of S.W.A.T., as well as overwatch, support, and observation missions. (Photo courtesy of HCSO)

training, practice, and qualifying with their G45s, which replaced another brand entirely. This nearly quarter-century of experience, including spending many years as a field training officer, has made Luckey a firm GLOCK fan. As he explained, "Our deputies have embraced the change to the GLOCK. Personally, I love its simplicity and the fact that it works."

Luckey oversees hundreds of deputies training on the HCSO range every month. He told me, "Based on my involvement in training, while guns shouldn't have to take neglect and abuse, they unfortunately do, and the GLOCK just keeps on shooting. It is an incredibly durable weapon and my top choice for a service pistol based on that."

Luckey went on to explain how one of the GLOCK Gen5 features, the Modular Back Strap System, has improved both his performance and accuracy with the G45. "I prefer to get very high on the handgrip of the pistol," he said. "The ability to install a long tang to protect my hand while obtaining my preferred and most accurate hold is simply tremendous. Without that, I would be having the painful 'double tracks' of the slide riding over the web of my hand while shooting."

Each G45 Gen5 pistol comes with two sets of easily interchangeable backstraps, providing every handler with three sizes from which to choose. Luckey noted, "When we made the transition to the G45s, we worked with the deputies to determine which grip size worked best, and, of course, they left with the extra backstraps so that they could change it at a later time if they wanted."

Another feature Luckey appreciates is the GLOCK SAFE ACTION® system. After discussing a time in which he had to teach and use firearms that had a double-action/single-action operation, he concluded that having the singular smooth and crisp trigger pull of the G45 is a real advantage both in training and on the street. He said, "The consistent trigger pull makes it easy to teach, and I really appreciate that after dealing with other designs." The G45's excellent, accuracy-enhancing trigger is also, as all GLOCKS have been since the first generation, completely safe due to the trio of internal safeties that prevent firing except when the trigger is purposefully depressed.

AN ALL-AROUND PRO SINGS PRAISES

With almost 25 years in law enforcement to her credit, Training Specialist Kim Stroud is a GLOCK-trained and qualified armorer for the Hillsborough County Sheriff's Office Training Division. She is also an experienced gunsmith and champion pistol competitor who spent over a decade as a professional shooter. During her time competing, Stroud won the IPSC Nationals, ranking in the top five for many years in the United States and fourth in the world overall. Joining the Hillsborough

"I love their guns, and they are the best, but their customer service beats their guns."

County Sheriff's Office and now assigned as its armorer, Stroud participated in the agency's transition to the G45 where she had the opportunity to thoroughly evaluate the pistol and its usefulness to the department's deputies. That included trying out a loaner pistol provided by GLOCK, and she was impressed with how well it shot. "I set a target out at 50 yards and went prone, and using a pistol that had already had many rounds put through it, shot a three-inch group." Impressive!

Talking with Stroud in the HCSO Armory, she candidly stated, "I love the G45, absolutely love the gun. It is extremely well balanced and shoots incredibly well. Since 2018, we have assigned over 1,600 new GLOCK pistols to all of the sworn Hillsborough County deputies."

All those pistols have been in constant service, with tens of thousands of rounds put through them during training, practice, and qualifications. "Even with all those deputies and guns, virtually nothing has gone wrong, just a couple issues I addressed with a simple change in parts." When asked about her experience with GLOCK customer service, Stroud answered, "They are awesome! No matter anytime you call or for whatever the reason, they will listen and respond immediately. I haven't had to ask, but I know they will walk you through any problem, step by step, until the issue is resolved. I love GLOCK's guns, they are absolutely the best—but GLOCK's customer service is even better!" ☺

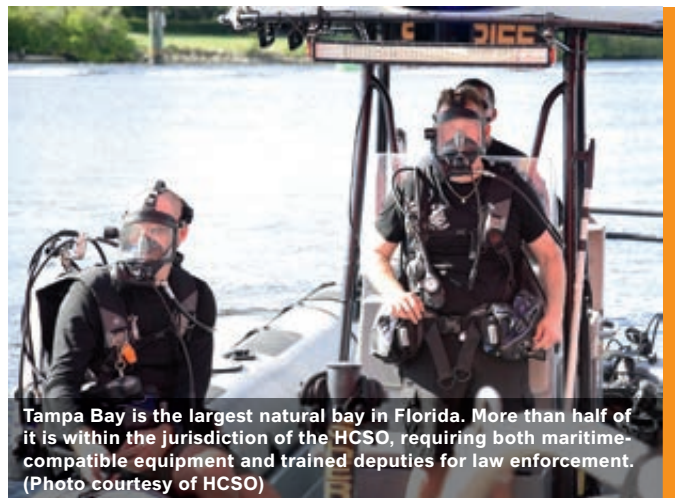

Tampa Bay is the largest natural bay in Florida. More than half of it is within the jurisdiction of the HCSO, requiring both maritime-compatible equipment and trained deputies for law enforcement. (Photo courtesy of HCSO)

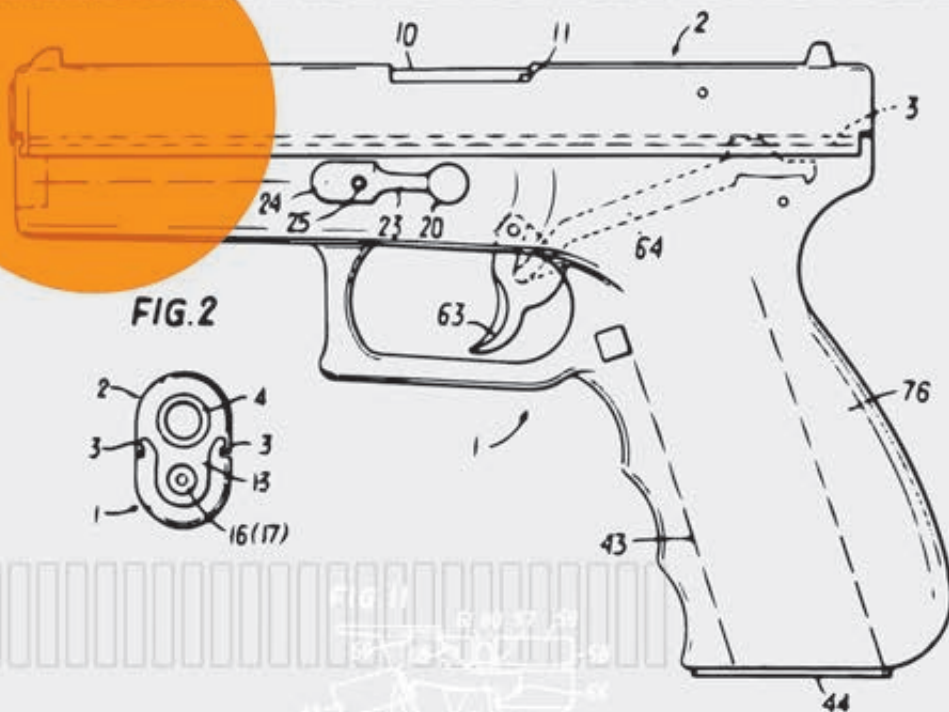

SECURING THE WORLD

**IT TOOK ONE MAN TO THINK OUTSIDE THE BOX
WHEN IT CAME TO HANDGUN PERFORMANCE AND RELIABILITY—
AND THE RESULTS TOOK THE WORLD BY STORM.**

■ ARTICLE BY CHRIS EGER

Do you know what GLOCK has in common with large defense contractors like Lockheed Martin, General Dynamics, and Raytheon? They are all top competitors in their respective fields for Request for Proposal (RFP) or Request for Tender (RFT) government and non-government corporate security contracts, awards highly sought after for their scale of fulfillment and the accompanying international bragging rights. Such contracts require prospective vendors to meet an extensive list of requirements that leave less-worthy companies in the dust—so it is deeply impressive that GLOCK is a leader in securing dozens of military and law enforcement tenders around the world.

Founded in 1963 by Gaston Glock, GLOCK's first military products included field knives, grenade components, and machine-gun belt links. Twenty years later, the company's flagship GLOCK 17—that ground-breaking, striker-fired, polymer-framed 9x19 handgun using the revolutionary GLOCK SAFE ACTION® system—had morphed from a prototype to finished product and won the first government tender for which it was submitted. It was soon adopted to replace the Austrian Army's legacy pistols—and that was only the beginning.

COMING TO NORTH AMERICA

Austria's military and law enforcement are hardly alone when it comes to holstering GLOCKS.

In 1986, GLOCK landed on U.S. shores, setting up operations in Smyrna, Georgia. It is still located there today—and thriving. More advanced than other handguns on the market when it arrived on American soil, the G17 had a comparatively simpler design, one using minimal parts. It was also lighter at just 27.9-ounces loaded, and that was a statistic its competitors could not beat. The icing on the cake was the G17's reliability. How reliable? In 15,000-round tests performed on first-generation guns, the G17 delivered every time the trigger was pulled.

With such positives, the design was on a smooth trajectory to win over law enforcement agencies from small towns to big cities. Though there was some initial trepidation over the gun's rather futuristic styling, that fell away once officers got their hands on the G17 for evaluation.

Dependable in mud, rain, ice, and heat, the G17 soon spread coast to coast. When the more compact GLOCK 19 debuted in 1989, the pair quickly became the handgun staples of American law enforcement. The subcompact models such as

GLOCK's reputation for perfection has been key in the selection process for towns, cities, and countries around the world seeking to equip their public-safety guardians with the most modern and effective sidearms available.



the GLOCK 26 and GLOCK 27 were added next, both of which became popular with detectives and plainclothes personnel who needed more concealable sidearms.

North of the U.S. border, provincial police in much of Canada, including Ontario and Quebec, have long carried GLOCK 9x19 handguns, while officers in Western provinces typically opt for .40 AUTO models. All told, by 1999, more than 2,000 North American law-enforcement agencies, stretching from the snowy Alberta to the sunny Miami, had adopted a GLOCK pistol. In just one example of how these guns had proven themselves to survive anything, five GLOCKS in service with the Biloxi, Mississippi, Police Department were completely submerged in saltwater during 2005's Hurricane Katrina. All were later deemed, after simple cleaning and inspection, to still function flawlessly.

GLOCKS continue to see steady adoption by local and state departments and federal agencies such as the DEA, ATF, FBI, and others. U.S. Customs and Border Protection, the largest law enforcement agency in the federal government, selected a variety of GLOCK Gen5-technology handguns in 2019, and the U.S. Secret Service quickly followed suit.

EUROPE

While Austria is a neutral power and during the Cold War was astride the tense border between eastern and western Europe, GLOCK handguns soon saw adoption across the divided continent. NATO-allied Norway and neutral Sweden replaced assorted World War II-era pistols with the G17 in the early 1980s. Others followed, including the Dutch military's

adoption of, first, the G17 Gen3 in 1994, then upgrading to GLOCK Gen5 model in 2016.

Behind the former Iron Curtain, Poland, Romania, and the Baltic States opted for GLOCKS as soon as relations thawed. Non-aligned Finland and Switzerland chose the G17. The handful of Danish Navy volunteers who man the Greenland-based Sirius dogsled patrol, possibly the most remote military outpost in the world, pack 10mm AUTO GLOCK 20s for personal defense against ill-tempered polar bears. Portugal replaced its circa-1940s 9x19 handguns with new G17 Gen5s in 2019, not at all surprising when you take into account the country's national police force had long before adopted GLOCKS. In Germany, the G17 is in common use with both state police forces and federal tactical teams. The Vatican's city-state's gendarmes and the Pontifical Swiss Guard carry GLOCK handguns, and while the Icelandic Police are generally unarmed when on patrol, when an especially dangerous threat arises, they, too, call on GLOCK.

The British Army went GLOCK in 2017, phasing out Commonwealth-made guns that dated back to the days of King George VI and an era when the average "Tommy" carried a bolt-action rifle. In early 2020, the French military likewise selected GLOCK after a grueling head-to-head test against competing combat pistols, ordering almost 75,000 two-tone G17 Gen5 models to equip not only the Republic's army but also its Navy and Air Force troops, making it possibly the first time in modern history that British and French soldiers carry the same handgun. It seems one of the things Europe can agree on from Bucharest to Paris and Helsinki to London is that "GLOCK" requires no further translation.

THE MIDDLE EAST

The well-funded, oil-rich monarchies of the Middle East can afford to buy any equipment desired for their public-security forces, and more often than not, these vital U.S. allies eschew pricier guns and go with GLOCK. From Jordan's elite Royal Guard of King Abdullah II and the officers of the Royal Saudi Army to the ultra-modern Maserati and Bugatti-driving Dubai Police Force, many countries in this sometimes volatile region rely on GLOCK handguns to ensure their safety. Speaking of which, the reformed Iraqi Security Forces, molded on a Western model and trained by professional military and police missions provided by U.S. and Coalition allies over the past two decades, extensively utilize G19 pistols in their daily efforts against crime and terrorism.

ASIA AND OCEANIA

The GLOCK is standard-issue among security and law enforcement agencies around the Pacific, with various models in use with the Royal Malaysian Police Force, Philippine National Police, Royal Thai Police, and by most governmental agencies in South Korea. The respected city-state of Singapore, in 2019, moved to replace its outdated .38-caliber revolvers with GLOCK 9x19 pistols for its well-organized Singapore Police Force.

Down under, the Royal Australian Air Force issues its flight personnel headed into harm's way the G19 should they have to hit the silk in dangerous territory; the ever-reliable handgun was dubbed the "Jet Aircrew Pistol" in RAAF service. Neighboring New Zealand issues GLOCKS across its entire body of armed forces.

WORLDWIDE APPEAL

In many ways, it is a short list of agencies and militaries around the world that do *not* carry GLOCKS. It would seem that the often-reported "GLOCK Perfection" is a universal phrase with those seeking to equip their public-safety guardians with the most modern and effective tools. After all, there's really no sense in arguing with perfection. 🍷

Imagine the



These instructors from Georgia's Sandy Springs Police Department were among the very first to take part in the MOS Instructor Course offered by GLOCK Professional, Inc. The course helped guide the way for the agency's adoption of the GLOCK 45 MOS.

GEORGIA'S SANDY SPRINGS P.D. ADOPTS THE GLOCK 45 MOS

A TOWN THAT FOR DECADES LACKED ITS OWN POLICE DEPARTMENT NOW HAS ONE MORE THAN 150 OFFICERS STRONG AND DEDICATED TO A PARTNERSHIP WITH ITS CITIZENS—AND SOON, THOSE OFFICERS WILL BE PROTECTING THEIR COMMUNITY WITH THE GLOCK 45 MOS.

■ ARTICLE BY SEAN CURTIS

Georgia's Sandy Springs Police Department (SSPD) was formed in 2006. While it does not have a long history, it enjoys a strong and positive relationship with the town's citizens. This is due in part to the excellent services its officers provide but it's also attributable to the residents of Sandy Springs knowing what it's like to not have their own police force.

A CITIZENRY UNITED

SSPD Public Information Officer Sergeant S. Ortega told me that, years ago, Sandy Springs only received law enforcement services from three county police officers assigned to the area. These three were spread thin among the area's permanent 100,000 residents, a number that swells to 300,000 during the day. Facing increasing demands for a more robust police department, the city finally made the decision to form its own. Today, nearly 160 sworn officers work to make Sandy Springs a better place, with 20 to 30 officers per shift standing ready to make a difference in their community. Soon, those officers will be performing their jobs with the GLOCK 45 MOS at their sides.

Sergeant Ortega said the department is very proactive and works hand-in-hand with its constituents, including using a Citizens on Patrol program made up of volunteers. These valued members assist with a variety of calls, which give them a deeper understanding of the challenges faced by uniformed professional officers. Critical resources such as a K-9 Unit, S.W.A.T. Team, Traffic Unit, Street Crimes (crime suppression), Investigations, Narcotics, Crime Scene Investigation, Crime Intelligence Unit, and dedicated Task Force Officers work with other agencies in the area, completing the picture of an agency designed to address a variety of needs. The design has been so successful that the agency has reduced the murder rate in the jurisdiction from an average of six to 12 victims annually down to three.

Sergeant Ortega described SSPD's Chief Kenneth DeSimone, a retired colonel with the U.S. Marine Corps Reserve, Military Police, as a forward-thinking leader who emphasizes the importance of training officers and adopting emerging technologies. SSPD was one of the first agencies to implement body-worn cameras in the area, and it also employs digital crime-scene scanners and advanced cellphone investigative tools. It is certain this approach to embracing new technologies is what led the agency to be among the early adopters the GLOCK 45 MOS.

LIFE-SAVING TECHNOLOGY

I spoke with Sergeant David Roskind, head of the Training Unit, about SSPD's process for making the decision to acquire the G45 MOS. He explained that some time in 2018, the agency began to consider switching to a weapon system that included optics. Roskind said the department sent a group of its instructors to a GLOCK MOS Instructor's Course taught by GLOCK Professional, Inc. He later learned his agency was the first to attend that training.

Describing the course as one of the most challenging he'd ever attended, Roskind said the GLOCK Professional instructors confronted years of his previous education in stance, grip, obtaining the dot of a red-dot optic, and keeping the dot. After what amounted to a makeover of these skills, the Sergeant described it as one of the best experiences he'd had, emphasizing that such a statement was no small praise coming from an officer with 33 years on the job.

Roskind also added that his evaluation of the course was based on a single critical principle. His previous handgun



The move to acquire the G45 MOS has been so well received that job applicants to the agency perceive it as an incentive to become Sandy Springs police officers.

Richard King Photo

training had, naturally, focused on obtaining the front sight superimposed over a blurred target in the background. Using the G45 MOS in the GLOCK Professional course allowed students to focus strictly on the target while confirming the dot was covering it. In other words, they were being taught target-focused shooting. Roskind noted that, as a result, shooters were able to learn to shoot with both eyes open, allowing for greater situational awareness, better target assessment, and improved shot placement.

Chief DeSimone conferred with the instructors who'd attended the training with GLOCK Professional, all of whom reported they'd learned a great deal. Accordingly, the chief approved further investigation into adopting the G45 MOS.

In moving forward with that investigation, Roskind said he and the other instructors wanted to test the things they'd learned at GLOCK Professional by using a cross-section of the agency's officers, some of whom were not the best shooters. Nine officers attended a full day of training, shooting up to 1,000 rounds each. The first group of five improved from an average score in the 240s (out of 300 possible) to 278. The second group started with a similar baseline score but improved to an average score of 275 using the G45 MOS. Two other metrics used to measure performance were time and misses. Officers were evaluated on how quickly they were able to draw, get on target, and engage the target. He said officers significantly shortened their times with the G45 MOS, some cutting off four seconds and others trimming as much as 25 seconds! Total misses also diminished noticeably. With such positive transformation in these officers' shooting skills, Roskind knew they had definitive proof the G45 MOS would benefit the entire agency in its critical competency.

HOPE FOR 2020

Sergeant Roskind credited Training Officer Jake Miller for taking the lead on the firearm transition process, adding that SSPD, at the time this *GLOCK Annual* went to press, was in the bidding process to make the transition to the G45 MOS. He also said that many applicants for law enforcement positions were enthused to hear the department was making this change and looked at the change to these new GLOCKS as an incentive to join the department. Sergeant Ortega said that underscores the fact that the citizens of Sandy Springs know what it's like to live in a city with little to no police—and that they don't want to live in that world again. ☉



Police officers of all ranks prefer to stick with the tools that work, often resisting changes to new technology. GLOCK's MOS pistols have been a game-changer in that regard, with widespread adoption as officers quickly learn to appreciate the benefits of a red-dot sight.

GLOCK: TURNING SKEPTICS INTO BELIEVERS

LAW ENFORCEMENT THROUGH THE AGES HAS BEEN NOTORIOUSLY RELUCTANT TO ADOPT NEW TECHNOLOGIES WHEN IT COMES TO THE FIREARMS IT TRUSTS. GLOCK DISTRICT SALES MANAGERS ARE OUT TO CHANGE THAT.

■ ARTICLE BY SEAN CURTIS ■ PHOTOS BY RICHARD KING

Taylor Crowley, District Sales Manager for GLOCK, came from law enforcement, and he's seen changes in the technology used to get the job done over the years. He also knows that such change often happens at a snail's pace.

That reluctance to change and upgrade is typical. Law enforcement, by nature, is apprehensive about new technology. Agencies want and need to feel confident about the effectiveness of something before they change operating procedures. That's understandable—you want to stick with what works, or at least the devil you know.

Police personnel from the top brass to the newest boots on the street hold that attitude. Part of it's because they incur a professional hazard in dealing daily with people who are less than forthright with them. Over the years, and beyond the criminals they deal with, they tend to become skeptical of claims that exceed their expectations. Proof is what's needed.

Crowley gets that. So, he was surprised when he began seeing rapid adoption of red-dot optics by law enforcement. He shouldn't have been, because he had the proof those agencies needed: 20 GLOCK 45 MOS 9x19 pistols equipped with red-dot sights.

TALK THE TALK— BUT MAKE SURE YOU WALK THE WALK

Tell a cop their agency can purchase a sidearm system its officers can quickly adopt, and they may not be too disbelieving. Tell them that same system is accurate, dependable, and offers improvements for officers with aging eyes and enhancements for those who don't maintain their weapons well, and they might start to balk a little. *Then* tell them they'll also have fewer mistake-of-fact shootings because of improved target focus, not to mention a more intuitive shooting platform officers of all ages and physical capabilities

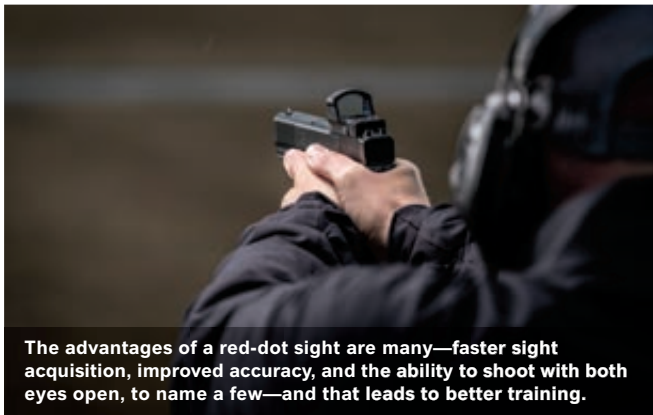

The advantages of a red-dot sight are many—faster sight acquisition, improved accuracy, and the ability to shoot with both eyes open, to name a few—and that leads to better training.

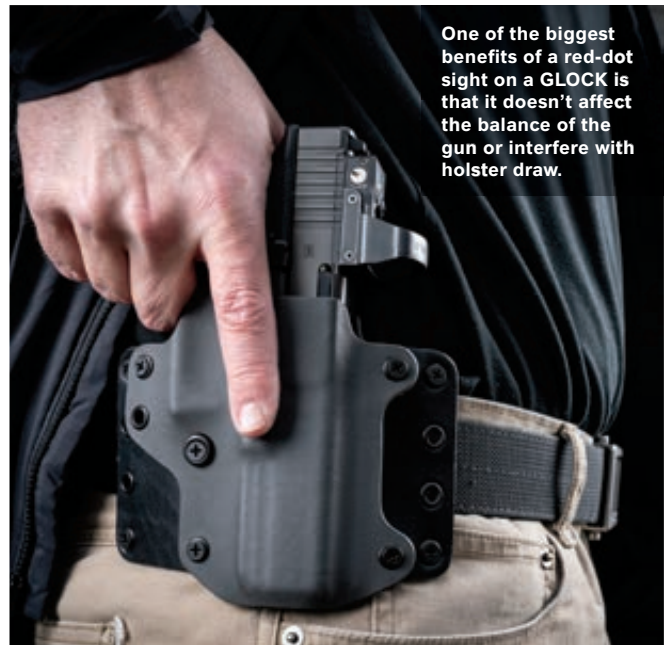

One of the biggest benefits of a red-dot sight on a GLOCK is that it doesn't affect the balance of the gun or interfere with holster draw.

can successfully deploy—well, they'll probably fold their arms across their chest and raise an eyebrow. They may even walk away. However, if you show them everything you've just promised, you will make them a true believer. That's what Crowley aimed to do.

IF YOU BUILD IT ...

The first thing he needed was a big enough venue to host his event. Maryland's Frederick City Police Department has an outstanding range that was large enough to accommodate Crowley's auspicious plan, and it agreed to host the demonstration, one in which multiple agencies from the region could attend with ample room to train on the new equipment. He coordinated the logistics with Frederick PD's rangemaster, and in January 2020, the invitations went out.

Having a place to demonstrate the new GLOCKS was one thing, but Crowley wanted more.

He quickly assembled several industry-leading companies to put on something of an industry range day. Among them was Federal Ammunition, which conducted a ballistic gelatin test to FBI standards that compared the viability of the 9x19 round against the .40 AUTO. Another was 3M's Hearing Protection Division, whose staff demonstrated some of their products while educating attendees about hearing protection and how important it is over the course of an officer's career. With his corporate partners on board, Crowley then created a raffle for the day, with a free GLOCK pistol, backpacks from 5.11 Tactical, 3M's top-tier ComTac III hearing protection, weapon lights from Nightstick, and a case of 9x19 ammunition supplied by a local gun shop among the "swag" that was up for grabs.

On March 10, Crowley and his GLOCK demonstration guns, along with 60 officers from 15 different agencies, arrived at the Frederick City P.D. range. The day started with a ballistic gel test. Witnessing the 9x19's terminal ballistics perform similarly to that of .40 but with less felt recoil left a remarkable impression on the gathered professionals.

Crowley moved next to a training session with the G45 MOS. Corey Watson, a GLOCK instructor, started in the classroom with a discussion about the science behind red-dot sights and how he'd be able to smoothly transition the officers from using their iron sights. The range time and live-fire with the G45 MOS 9x19 that followed quickly drove the lessons home.

ONE TOOL, MANY BENEFITS

By the end of the day, Crowley said he felt like all the officers who attended had a solid grasp of how the G45 MOS could benefit their agencies. By adopting red-dot technology, they could transition from front-sight focus to target focus. That's something that often naturally happens in use-of-force scenarios, but, with iron sights, the results can be disappointing—or fatal. The officers also discovered they could

keep both eyes open, increasing their situational awareness, and those with compromised eyesight shot better with the red-dot sights.

When it was all over, Crowley knew he'd presented a law enforcement shooting demonstration that was without competition. He noted that the G45 MOS shines at 15, 25, and even 50 yards. Calling it "the proof in the pudding," he set out to convince the officers with a friendly competition in which each got one shot to hit the long target, with the one closest to the center mark winning. He said several officers were amazed at just how easy it was to engage targets accurately at that range. 🍷



GLOCK Professional instructors and members of Team GLOCK were on hand to help law enforcement officers attending a demo of GLOCK 45 MOS pistols acclimate to the new technology.

Taylor Crowley had a mission, and that was to show the law enforcement world that a G45 MOS with a red-dot optic was a change for which reluctance and apprehension have no place. Given the response from those who attended his demonstration, we think he nailed it. And the good news is that you don't have to reside or work in Crowley's Eastern Seaboard region to get a glimpse at all GLOCK has to offer, because GLOCK District Managers host demonstrations all across the country. If you're a member of the law enforcement community and wish to take part in a demonstration of GLOCK products, contact your area GLOCK representative or sales manager for arrangements. For more information, visit us.glock.com or call 770-432-1202.



PORTUGUESE ARMY CHOOSES GLOCK 17 GEN5 COYOTE AS NEW SERVICE ARM

GLOCK'S ICONIC PISTOL IN ITS FIFTH GENERATION BECOMES THE NEW SIDEARM OF THIS PRESTIGIOUS MILITARY CORPS.

■ ARTICLE BY BRYAN FERREIRA

The Portuguese Army, since 2018, has been in the process of fitting its soldiers with new personal weaponry through the NATO Support and Procurement Agency (NSPA). In 2019, the tender for the purchase of new pistols was concluded, with GLOCK winning a contract for an initial order of approximately 3,000 firearms. The winning model was the GLOCK 17 Gen5 9x19, which the Portuguese Army will use to replace its veteran Walther P-38 9x19 pistols.

The Portuguese Army assembled requirements for the firearm companies to participate in the tender that were simple. First, the gun would have to be in current service in a NATO country, so as to exhibit proven technology. It would have to be in the coyote/flat dark earth color, in order to provide an improved level of concealment, and it would have to have a standard barrel size. The magazine capacity would need to be equal to or greater than 15 rounds.

In terms of mechanics, the weapon would need to be without an external safety, so that it could be quickly deployed. (The Portuguese Army's sidearms are "resource weapons" used mostly in cases of urgency.) The firearm would need to be capable of safe carry with ammunition in the chamber, and it would also need to be drop-safe while loaded. The weapon would have to be ambidextrous, come originally equipped with luminescent metal sights and three magazines, and it would need to be unequipped with an external hammer, in order to be as airtight as possible to prevent dirt and debris from having an effect on its performance.

Richard Flür, Director of International Sales at GLOCK GmbH, said, "We are proud to be selected to support the missions of the Portuguese military with the latest generation of GLOCK pistols. The Portuguese Army is among multiple

military and law enforcement entities that GLOCK strongly supports in the region, and we are excited to welcome them to the GLOCK family."

The Portuguese Army's G17 Gen5 9x19 comes with all the features of other Gen5s, as well as additional enhancements borrowed from the GLOCK 19X. Those enhancements include the GLOCK Coyote-color frame, slide, and magazines, as well as the luminescent steel sights. A lanyard clip was also included.

With this acquisition, the Portuguese Army, which also recently purchased FN SCAR assault rifles, is now equipped with one of the best small-arms combinations needed for combat. This upgrade was very important to this military body, as Portuguese Army Elite Units (paratroopers and commandos) have been engaged in heavy firefights in the United Nations Multidimensional Integrated Stabilization Mission (MINUSCA) in the Central African Republic (CAR). In fact, the Army's new GLOCKS are already being deployed to the CAR and have been performing in an exemplary manner under the strenuous hot and humid weather of the region and the heavy red dust that accumulates everywhere. That red dust becomes even more of a problem in the rainy season when it turns into mud and further makes difficult already complicated combat operations. Soldiers on the ground are absolutely pleased with their new GLOCKS in this regard, and all reports are favorable in terms of maintenance and reliability. The new pistols are also currently deployed to other Portuguese Army missions in Afghanistan and Mali, again with excellent reports.

The Portuguese Army is now part of a family of military bodies that trust in GLOCK to provide them with a sidearm they can count on when the time comes to save lives. GLOCK wishes them success in their endeavors and is looking forward to many years of providing service to them. ☉

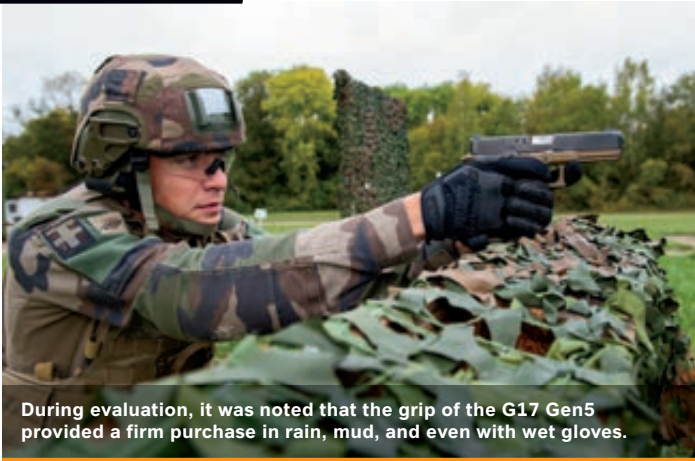

During evaluation, it was noted that the grip of the G17 Gen5 provided a firm purchase in rain, mud, and even with wet gloves.



Infantry personnel will be well served with their new GLOCK G17 Gen5s, which are replacing pistols from the 1950s.

PROTECTING FRANCE: THE REPUBLIC ADOPTS GLOCK

THE LAND OF THE EIFEL TOWER, EXTRAORDINARY WINE, AND ROMANTICS IS NOW BETTER PROTECTED WITH GLOCK 17 GEN5 PISTOLS.

■ ARTICLE BY CHRIS EGER ■ PHOTOS COURTESY OF THE FRENCH ARMY

After a grueling trial and evaluation process, the French Ministry of the Armed Forces, in early 2020, announced the country would be going GLOCK to replace pistols dating from the 1950s. In all, some 74,596 GLOCK 17 Gen5 9x19 handguns will be acquired through 2022 to equip the French Army, Navy, and Air Force, with the land-element regiments receiving some 80 percent of those *pistolet semi-automatique* (PSA) in service.

Captain Guillaume de Massia, staff officer for the Department of Infantry Studies and Foresight at the French Army Infantry School, wrote in the summer 2020 edition of *Fantassins*, the branch's official periodical, about the new GLOCKS. De Massia said that while earlier generations of the G17 already equip some commando units such as COM FST, the Gen5s will be intended for special operations troops, as well as for dismounted warfighters in the infantry where it would be used as a secondary weapon. The new GLOCKS will also be deployed in confined spaces such as in vehicles for extraction use or when fighting in subterranean spaces.

In a June 2020 statement from the French Ministry of the Armed Forces, two of the key factors leading to the adoption of the GLOCK handgun was the "reliability and robustness" it demonstrated during testing. De Massia, in his article, echoed these sentiments, describing the particularly rigorous evaluation to which the pistol was subjected, even referring to the magazines as *increvables* (indestructible), and noting that the nDLC finish was particularly resistant to heavy use. He also added that the GLOCK's ergonomics are suitable for all hand sizes due to the

Modular Backstrap System, while the grip's texture provided good purchase in all conditions, including in rain and mud or with wet gloves.

The G17 model adopted by the French military includes standard Gen5 technologies, including the GLOCK Marksman Barrel (GMB), an ambidextrous slide stop lever, and a flared magazine well. Among more than 20 enhancements over the Gen4 GLOCK pistols, these Gen5 pistols are now without finger grooves. De Massia said the suppressor-ready pistols that also have the option for including GLOCK's Modular Optic Systems (MOS) will be used by elite Parachute Commando Teams, Mountain Commando Teams, and military working-dog units.

GLOCK is increasingly the choice for NATO militaries. Its pistols are in regular use by the armies of Great Britain, the Netherlands, Norway, Portugal, and Romania. ☉

The author and GLOCK extend their thanks to Captain De Massia and Fantassins for their help with this article.





SAVE A RHINO, SAVE A LIFE

WHEN YOU'RE FIGHTING POACHERS IN A PLACE WHERE REPLACEMENT GUNS AND PARTS ARE VIRTUALLY NONEXISTENT, YOU CHOOSE A SIDEARM THAT MUST WORK ALL THE TIME, EVERY TIME. THAT SIDEARM IS GLOCK.

■ **ARTICLE BY TERRICK NAUDE, GLOCK SOUTH AFRICA**

Rhinoceros poaching is a massive problem in South Africa. These magnificent prehistoric beasts are dying in droves at the hands of poachers in search of their horns. One of the most successful methods to fight these poachers is taking away the thing they're after, rhinoceros horns, in a process in which the animal is darted, sedated, and has its horn either trimmed or removed.

Rhino 911 (rhino911.com) is a non-profit organization in South Africa that fulfils many tasks in this field. Its people provide air support to anti-poaching units, along with veterinarians who treat rhinos and other animals that have been injured. They are on the very tip of the fight to save what is left of the country's rhinoceros population—and they describe what they are facing as nothing short of war, one with many threats.

Chief among these threats are the criminal cartels operating the poaching rings. Neither the cartels nor the poachers feel any compunction taking the same automatic weapons with which they poach and turning them on honorable people working to save these remarkable animals.

Nico Jacobs expertly pilots a little Robinson R44 over the South African Bushveld. A small but capable helicopter equipped to be used night or day, it bristles with cameras and thermal-imaging devices. Sometimes, Jacobs is equipped with night-vision goggles.

The poachers Jacobs faces are also equipped with night vision. They have large-bore rifles and AKs, too, which they regularly use to try to shoot the helicopter out the sky. Flying a helicopter is a





Rhino horns are highly valued for supposed medicinal value and part of a thriving black-market trade in wildlife parts. These horns were humanely removed from anaesthetized South African rhinos by Nico Jacobs' Rhino 911 team.

complex operation in and of itself, and piloting one at night is an even more arduous proposition. Flying one at night while avoiding bullets and trying to return fire easily earns an 11 on the difficulty scale of one to 10.

When you are trying to deal with all of this, you cannot question the reliability and safety of your pistol. You simply don't have the time nor the opportunities to baby any of your gear. That is why Jacobs and the crew at Rhino 911 proudly choose GLOCK. Experience has shown them that they require a pistol that will work when it's needed, no matter the weather, and even when it's so caked in African sand and dust that their black pistols looks red. When you're keeping a chopper off the ground or hanging out the its door looking at the ground, you don't have time to cycle the slide or any other silliness to get your pistol into action. And you definitely can't afford something so unreliable it's going to require you to clear stoppages or other malfunctions while the action is happening.

Jacob has used his pistol to save rhino lives beyond his time in his helicopter. Rhinoceroses are famously grumpy, and when a bad-tempered rhino wakes up after being anaesthetized to be dehorned or to have a poacher's bullet wound treated, it becomes an even grumpier rhino. Understandable, but a cranky rhino doesn't take the time to differentiate between who's trying to help it and who tried to hurt it, and that means any person, vehicle, and even a helicopter can become the target of tons of angry megafauna. A warning shot from a handy GLOCK serves very well to redirect them without injury to rhino or crew.

Jacobs and his crewmates, Leonie and Adam, knew they couldn't compromise when it came to choosing a pistol. They've each chosen the GLOCK that best suits their personal



A rhino tranquilized for horn removal. By removing the horns, the team at Rhino 911 removes the reason to poach these animals.

requirements: Jacobs a classic GLOCK 23 Gen2, Leonie a GLOCK 26 Gen4, and Adam a brand-new GLOCK 19 Gen5. Being in a place where access to handguns is far more difficult than in the U.S., they needed to know their pistols will last and that they'd be able to service and maintain them for decades. More importantly, each knows that, when they find themselves dealing with violent criminals and backup is nowhere in sight, they have a pistol they can depend on.

Rhino 911 and GLOCK Perfection. Together, they're in pursuit of their mission statement, "Save a Rhino, Save a Life." 🍷

Nico Jacobs saddled up with a canine partner and about to set out for their work fighting poachers in South Africa's bushveld.



The helicopter-bound crew of Rhino 911 also treats wounded rhinoceroses, in addition to fighting off their poachers.

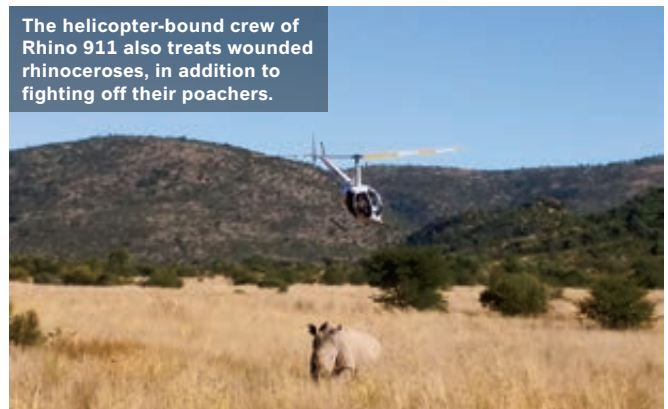

GLOCKs FOR SOUTHPAWS

THE GLOCK IS AMENABLE TO LEFT-HANDED SHOOTERS. WE SHARE TIPS FOR LEFTIES TO GET IT RIGHT—AND RIGHT-HANDERS, THERE'S SOMETHING HERE FOR YOU, TOO.

■ ARTICLE AND PHOTOS BY MASSAD AYOOB



Did you know that southpaws can dump an empty magazine faster than righties? By using their trigger finger on the magazine catch (here on a GLOCK 17 Gen5), less manipulation of the gun is needed to achieve the goal.

The arrow shows how the opposite side of the magazine catch protrudes when depressed. Have your trigger-hand thumb clear to avoid blocking it.

Most handguns were designed for the right-handed majority. It is estimated that 10 to 12 percent of people are left-handed, and while shooting techniques can be seen as mirror image between “righties” and “lefties,” that’s not necessarily so for all needed pistol manipulations. So, while this is geared toward best practices for left-handed shooters, if you’re a right-handed shooter, pay attention, because the day may come when your left hand is the one with which you need to run your GLOCK. And, if you’re a firearms instructor, you definitely need to know how to teach a southpaw.

WORKING THE SLIDE-STOP

“Administrative handling,” the loading, unloading, checking, and cleaning of a firearm, often requires the slide to be locked open manually. When working with a completely unloaded GLOCK, you can leave the empty magazine in place and retract the slide to the rear, which automatically locks it open. However, in many shooting classes and pistol matches, sometimes you’ll have a partially loaded magazine at the end of a string of fire and need to accomplish this.

In such a scenario, you will have to perform several moves to lock the slide open. First, remove the magazine. Next, clear the live round from the chamber, retract the slide once more, and press the slide-stop lever upward to lock the slide open for inspection by an instructor or range safety officer.

With the exception of the Gen5s, all GLOCK pistols have the slide-stop lever only on the left side. It’s easy to manipulate upward for right-handed shooters. For left-handed shooters, two solutions are offered. Start with the gun firmly grasped by the dominant left hand and the gun pointed in a safe direction, then:

1. Lay your right hand over the top of the slide with the right thumb on the left side of the slide and pointed forward. If you place that right thumb directly parallel with the ejection port, the right thumb should end up adjacent to the slide stop lever when you retract the slide. Let the right thumb bring up the slide stop, allow the slide to come forward a tiny bit, and your slide will be locked open. Or ...
2. With your right hand, draw the slide to the rear and, if your left index finger is long enough and strong enough, keep it off the trigger and pointed forward while using it to lift the slide-stop lever up into the notch.

The Gen5 GLOCKs with ambidextrous slide stop, of course, negate using either of those two methods. Lefties can lock the pistol open in a mirror image of a right-handed shooter’s technique. The left hand still holds the frame and keeps the muzzle pointed in a safe direction, but now, as the right hand brings the slide back, the left thumb pushes up on the right-side slide-stop lever.



In this southpaw slide-stop technique, the right hand retracts the slide and the trigger finger of the left hand pushes the slide-stop lever up into place (arrow).



With this GLOCK 19 Gen5, lefties can use their firing hand thumb to operate the ambidextrous slide-stop lever. It's a fast and effective way to lock the slide open and an easy-to-learn technique.

LOADING

1. Out With the Old—Before you can insert a new magazine, you have to dump the old one. On most pistols, the magazine catch is on the left side of the grip-frame, situated for use by a right-handed shooter's thumb. Southpaws, don't despair, as you can probably work it faster than most righties. Why? Because to get the right-hand thumb to the button, most shooters have to break their hold a little, squirreling the hand around on the grip to get enough leverage to press that release. But all the southpaw has to do is maintain their firing grip with the three lower fingers and use the tip of the trigger finger to depress the magazine catch. A bonus is that this method guarantees that finger is out of the trigger guard during the reloading process.

Note that your left thumb will be along the right side of the grip while this is happening. Don't let it block the opposite side of the magazine catch, which would prevent a clean drop of the empty magazine.

For lefties who want to mirror your right-handed friends, the magazine catch on Gen4 and Gen5 GLOCKS is reversible and, thus, can be manipulated with your strong-hand thumb.

2. In With the New—For loading and reloading on the go, you'll want a magazine pouch. Most instructors and top competitors suggest carrying spare magazines on your non-dominant hand side, with the bullet noses to the front so that you get a positive seating when slamming a fresh magazine into your GLOCK pistol.

As your support hand comes down on the magazine in the pouch, let your palm hit the floorplate, index finger pointed straight down along the front of the pouch. Withdraw the magazine and turn your palm up as you bring it to the pistol.

A trick I learned from GLOCK-shooting former world USPSA Champion Frank Garcia is to have the magazine contact the magazine well's inside edge. That is, the left top edge of the magazine at the left edge of the magwell for southpaws, vice-versa for righties. Finish inserting with a single firm slap, all in one smooth movement.

Your reloading hand's palm is now under the gun butt, fingers pointed toward the top of the GLOCK. If the gun is completely empty and the slide locked back, you'll have to close the slide to load a cartridge into the chamber. The most common way is to pull back the slide with the support hand and let it fly forward. It's a solid technique, but not as fast as using the slide-stop lever.

Former Midwestern Regional Champion IDPA shooter David Maglio is now a full-time trainer at Concealed Carry Associates and Firearms Academy of Wisconsin. He's also a GLOCK aficionado and southpaw. At this point in the reload, he likes to sweep his right hand up the front of the firing hand until its web hits the front edge of the trigger guard. His right index finger is now pointed straight back along the left side of the frame, perfectly placed to sweep down the slide-stop lever before naturally sliding that right hand into his two-hand firing grip.

A variation of that is to bring the support hand fingertips up across the left-hand knuckles to depress the slide-stop lever.

A third method of closing the slide is for the shooter to press down the slide-stop lever with the tip of the extended index finger, something it's already in a position to do. Beware, though, that people under stress can do things out of sequence, so it's possible at speed to hit the slide-stop lever and release the slide *before* the fresh magazine is in place—and that means you hear a "click" instead of a "bang" at the next trigger pull. Using the support hand to drop the slide keeps that from happening.

If your GLOCK is a Gen5 with a slide-stop lever on each side of the frame, none of this is a concern. You can use either thumb to close the slide on a fresh cartridge.

CARRY GEAR

Many magazine pouches hold the bullet noses forward on a right-handed shooter's left side, which means they'll be backwards for a southpaw. Several manufacturers, such as Blackhawk, make pouches that work in either orientation. GLOCK's excellent magazine pouch is at the top of the list for concealment and speed—and it's completely ambidextrous.

Any southpaw shooter can tell you that left-handed holsters are in short supply. When you do find one, be cognizant that GLOCKS with extended magazine catches will now have those buttons facing your body, and a magazine can accidentally be released from a holstered gun if your left side bumps something.

SOUTHPAW TRICKS FOR NORHPAWS

Any of us can sustain an injury that takes a dominant right hand or arm out of action—and being in pain or in a sling or cast is a lousy time to start thinking about shooting leftie.

You already have a naturally ambidextrous gun—your GLOCK—so be smart and have an ambidextrous or dedicated lefty holster and magazine carriers. GLOCK's inexpensive Sport/Combat holster does nicely for range work and concealed carry.

Finally, if you're an instructor reading this, you will be teaching left-handed students. Think about it: How can you teach anyone to shoot safely and well, if you can't teach yourself to shoot well with your non-dominant hand? 🍷

GUIDED BY THE LIGHT LIGHT AND LASER ACCESSORIES FOR GLOCK PISTOLS

GLOCK TECHNOLOGY HAS MADE ADDING ACCESSORIES
EASIER THAN EVER BEFORE.

■ ARTICLE BY CHRIS EDWARDS

The idea of attaching a light to a handgun goes back many years, if not centuries. The advent of modern lights and lasers is what we're interested in today.

The practice of attaching an illumination device received a tremendous boost in the late 1990s with the introduction of the GLOCK Gen3 pistols, which had finger grooves and a GLOCK mounting rail system for mounting lights. Those lights were initially white. Lighting units back then, beginning with those from SureFire, were relatively large and had incandescent bulbs. Deploying them required holsters that were quite bulky, and their use was usually relegated to the special-weapons and tactical teams of law enforcement or military special-operations units.

I recall having one on a home-defense GLOCK pistol that pretty much lived in a lockbox and wasn't carried. In a matter of just a few years, though, that all changed.

First came a reduction in the size of weapon-mounted lights (WML), that advancement led by GLOCK and others. The GLOCK light/laser I have now (I should actually say my wife has it), is the GTL22, which has both a white light and a red laser.

As technology advanced, lights and lasers became both smaller and much more efficient. The development of more powerful light-emitting diodes (LEDs), those advancements spurred by the automotive industry, according to John Matthews, SureFire's founder, was a major boost to the lights designed to be attached to small arms. As I write this, I have a 1,000-lumen handheld light clipped to a pocket and a single 123 battery-cell weapon-mounted light (WML) on the GLOCK 19 Gen5 MOS I carry daily. That would have been rare, if not impossible, just five years ago.

ONE OPERATOR'S JOURNEY

As a sheriff's deputy decades ago, I had a large, battery-powered aluminum flashlight but no WML. I've always tried to keep up with developments, and today I've arrived at and am comfortable with equipment that's right *for me*. I emphasized "for me" for a reason. Others have different missions, needs, and limitations (not the least of which is financial), when it comes to adding accessories such as lights and lasers to their handguns. For example, a uniformed officer should have both



a handheld light of some power and a weapon-mounted light or lights. But the added expense may be a factor to an agency strapped for cash (or an officer on who might have to fund such equipment themselves). Lasers may even be contraindicated; when multiple officers are present and a situation has "gone to guns" or, at least, to a "defensive-ready" position—whose laser is whose? For an individual operating alone, for me, a laser makes sense. In a group setting, perhaps not.



One of my many blessings is to work with serious professionals at GLOCK, persons of vast and long experience defending America and enforcing the law. Hashing out and testing techniques and equipment with these pros has been extremely valuable. If you have a chance, find a skilled tactical trainer in your area—or make a journey to one you know has a great reputation—and discover the strategies for deploying weapon-mounted lights and lasers. It is training you won't regret.

TECHNOLOGY ABOUNDS—TAKE ADVANTAGE

In recent years, the free market has developed amazing options in the lights and lasers meant to be used in conjunction with handguns. Streamlight, SureFire, Inforce, Crimson Trace, LaserMax, Olight, and others have numerous products that can be applied to your personal-defense tools with success. But, safe training and practice are essential to making them work for *you*. It's a lifelong journey, and I am still on it (almost always with illumination these days)!

Through the years, I've attached and used lights and combination light/laser units on GLOCK models G45, G34, G22, G21, G17, G19, G43, G43X MOS and the G48 MOS. Manufacturers of those lights and lasers are many and include those made by GLOCK, each chosen to meet whatever my

“The free market has developed amazing options when it comes to lights and lasers for handgun use. Safe training and practice are essential and critical to making them work for you.”

mission is on any given day, from concealed carry about town or GLOCK Professional training classes (GLOCKTraining.com) to the defense of hearth and home. No matter what GLOCK or GLOCKS you have, it's worth your while to explore the advanced technology seen in today's lights and lasers for them. With training and regular practice, these tools will enhance your skills, accuracy, and confidence—and they just might save your life or the life of a loved one when the world becomes a dark, dark place. Light, laser, accessory, tool? Let's just call them “guiding lights.” ☉



GLOCK 44

A HANDGUN INSTRUCTOR'S NEW BEST FRIEND

**A .22 RIMFIRE IS THE PREFERRED CHOICE FOR FIREARM INSTRUCTORS—
AND THE GLOCK 44 MAKES TEACHING WITH ONE EASIER THAN EVER.**

■ ARTICLE BY CHRIS EGER

When GLOCK introduced its new GLOCK 44 .22 LR rimfire pistol in late 2019, many saw it as the perfect training companion to their favorite GLOCK centerfire models. Firearm instructors took the cue and quickly discovered it was not only an optimal tool for introducing new handgun users to shooting but one that rapidly warped the training curve for those seeking advanced proficiency.

COMPARING THE G44 TO THE GLOCK 19

The G44 has a size and layout nearly identical to the company's iconic GLOCK 19. This similarity gives the two guns a common fit and feel. In short, if you have ever handled or expect to handle a G19, the G44 feels nearly identical, though with one small difference: the weight. The G44, due to its innovative, hybrid steel-polymer slide, weighs only 15.94-ounces compared to the G19's 30-ounce heft, the 9x19 having more steel in its top half. Similarly, the surface controls—reversible magazine catch, slide-lock lever, and GLOCK's SAFE ACTION® trigger safety—are in the same place and work in the same way.

Because the functionality is largely the same across all GLOCK pistols, the G44 serves as an excellent primer for the use of any of the company's handguns, not just the G19. An individual who has learned on the G44 can pick up virtually any other GLOCK and figure it out in less than a minute.

NEW SHOOTER BENEFITS

To those who have never used a handgun before, the prospect of shooting one often involves a modicum of apprehension about recoil. The G44 excels in calming this fear, as it's minimal recoil helps new shooters focus on the proper manipulation of the gun and learn the fundamentals without being distracted by the *crack-boom* report and muzzle-flip of a full-power centerfire cartridge.

The G44 is also light and easy to control, with less front-end droop that improves the ability to keep it on target. Students don't "fight" the gun to keep it aimed where it needs to be. The adjustable rear sights and the precision of the G44's GLOCK Marksman Barrel (GMB) greatly aid accuracy, as does the G44's trigger pull weight of 26 newtons (5.85-pounds). In all, this is a gun that can provide instant rewards for the newly initiated.

LAW ENFORCEMENT AND SECURITY SUPER TRAINER

On the first day of every law-enforcement training or force-protection firearm class I hold as an instructor, I quiz attendees about their level of gun handling skills. Without fail, the responses run the gamut from those who have never shot a gun before to highly experienced individuals who would be comfortable teaching classes of their own.

Having a low-impact rimfire trainer available to jumpstart the less-experienced class members on the first day can be of

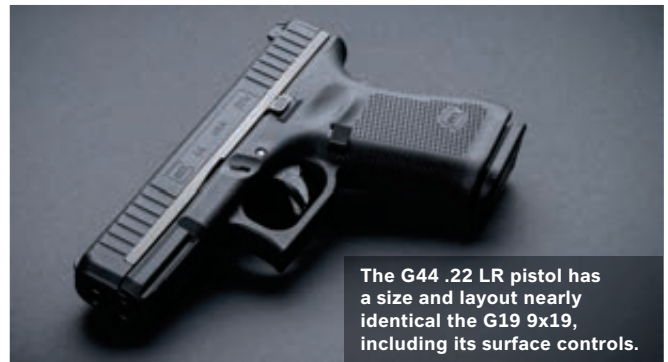

The G44 .22 LR pistol has a size and layout nearly identical the G19 9x19, including its surface controls.

great assistance in shepherding them to the same level as the rest of the class. Again, since the G44 loads, feels, functions, and handles like any other GLOCK, adding this rimfire to an agency trainer's toolbox can save time and frustration while helping to deliver the best-prepared students.

The same logic applies to officers looking to keep their skills sharp on a budget. Even with the price increases of recent years, 2,000 rounds of .22 LR is pretty much always going to be more affordable than 2,000 rounds of 9x19.

One additional thing to consider is that, while the G44 is one of the most reliable rimfire pistols I have ever shot, use of .22 LR with non-jacketed lead bullets, often found in bulk-pack ammunition, leads to extra fouling. As a rule, this means .22 LR-fed guns will be prone to more ammunition-related malfunctions than centerfire handguns of the same design. That sounds like a problem, but not when it comes to training with the G44. A G44 run hard by officers in practice can help with the occasional unplanned ammo-induced stoppage, and that's a training aspect that translates well to the real world.

PERSONAL-DEFENSE CLASSES

Being comfortable with a gun is a primary goal of owning a firearm for self-defense. If you aren't comfortable with it, you aren't going to invest the time to build confidence through practice, and if you aren't confident, you likely aren't going to carry your gun or trust it. This is where savvy individuals seeking firearm instruction for defensive purposes can benefit from a platform like the G44. Offered by instructors as part of a "crawl-walk-run" curriculum alongside red GLOCK practice pistols, the rimfire G44 helps build that confidence.

FINAL THOUGHTS

GLOCK has been in the U.S. for 35 years. In the G44, it has fielded the perfect rimfire pistol for beginners, experienced shooters, and especially firearms instructors who realize it can help improve skillsets for all involved. While the gun makes a great standalone choice for recreational target practice and fun competition, it is much more than that when used as a training tool—and, if utilized properly, it can help a good training program become that much better. ☉

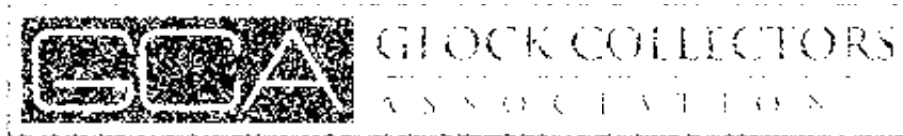

THE GLOCK COLLECTORS ASSOCIATION

GLOCK FANS JOIN HERE

AFICIONADOS BOND OVER A COMMON INTEREST,
SHARE INFORMATION, AND KEEP THE PASSION ALIVE.

■ ARTICLE AND PHOTOS BY ROBERT A. SADOWSKI

The GLOCK Collectors Association (GCA) is not just about collecting rare or unusual GLOCK pistols. Sure, the GCA warehouses valuable information on first-run GLOCKS, but it is also about sharing information about those pistols and others with its members and telling their stories. The common thread uniting those of us who are members is our interest in GLOCK history.

In the first half of 2020, with many people working from home and social distancing in place, the smartphone, iPad, and laptop grew in use as never before. During that time, the GCA website, glockcollectorsassociation.org, saw a sharp increase in visits. These visits were from people who fit the traditional definition of “gun collectors,” but there was also increased interest and inquiries from both men and women about what GLOCK would be best for them.

Some of these inquiries came from the influx of first-time gun buyers, tech-savvy shoppers who have done their homework. As they do their research and find the GCA, we refer them to the GLOCK website (us.glock.com) as the best source for GLOCK information. GLOCK ID (id.glock.com) is also a great source of GLOCK community information. For practical, hands-on info, the GLOCK Sport Shooting Foundation (GSSF) is a great place to get live-fire experience with a GLOCK.

Are members of the GCA biased? Heck, yes! We are, obviously, GLOCK fans. We have collected them and competed, protected, and defended with them. We are familiar with Gen1 through Gen5. We trust in GLOCK, and we believe that, once someone gains experience with the platform, they will trust it, too.

GLOCK FANS UNITE

By joining the GCA (glockcollectorsassociation.org), you are continuing your GLOCK journey, a journey on the history and generations of GLOCK pistols. One of the most valuable benefits of joining GCA is access to the Matrix, a compiled list of all “First Run Upon Introduction” GLOCK pistol serial numbers and prefixes.

With GLOCK’s gracious help, we update the Matrix as new models are introduced. The Matrix has increased from a few models since the 1990s to nearly 48 distinct models and more than 120 variations today. The Matrix allows owners to determine whether their GLOCK is a first run and, hence, a more valuable collectable.

Also included with membership is the annual *GCA Journal*. 2020’s edition included information on the GLOCK 34C pistols and what are known by GLOCK collectors as “ELP,”

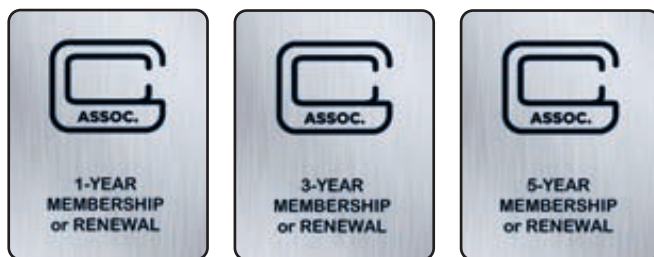

No matter which GLOCK Collectors Association membership term you choose, you’ll have access to the Matrix, a list of “First Run Upon Introduction” serial numbers and prefixes.

or factory-engraved, models. GCA members also receive a copy of the *Master Journal*, which includes the Matrix and a history on GLOCK 20 and GLOCK 21 models and cutaway guns. To complete the package, members receive a yearly commemorative patch. In 2020, the patch celebrated the launch of the GLOCK 44, GLOCK’s first .22-caliber rimfire pistol.

NUMBERS AND LETTERS TELL A TALE

GCA President Stanley Ruselowski, Jr., has been involved with the GCA nearly since its inception, and he’s a sage of GLOCK lore and information. Emails to him typically start with, “Hi, Stan, I recently picked up such-and-such model GLOCK, and my question is, does it have any collector’s value?”

The reason for this kind of question is usually rooted in the serial number. GLOCK produces pistols in serial-number runs of 0001 through 1000, so there are many 0001 guns in circulation. What separates a more valuable first-run 0001 from all the others is the lettered prefix.

An example. Perhaps some of the most valuable yet common GLOCK pistols are the early G19 pistols, often referred to as “Gen1.” These were developed at the request of law enforcement and have a “DN” serial-number prefix. Ruselowski also notes that some were, literally, cut-down GLOCK 17 pistols, and those also have a unique prefix and are extremely rare. The GCA’s Matrix includes all pistols made for the U.S. law enforcement and civilian markets.

The GCA would like to thank GLOCK for its assistance in gathering pistol model information and permission to use its logo. GLOCK is a world-class brand that cares about its customers, and we at the GCA feel privileged to be GLOCK insiders and a part of the company’s history. ☺



This year, 16 Matchmeisters competed for more than \$6,000 in cash winnings and prizes, with first-time competitors taking first and second places.



First-time Gunny Challenge competitor Brian Giovannini (left) took top honors.



This year's GLOCK Veteran and Law Enforcement Appreciation Event gathered military and law enforcement veterans for a friendly competition.

2020 GLOCK ANNUAL SHOOT XXVII & GUNNY CHALLENGE XVI

DESPITE PANDEMICS, HURRICANES, AND A HOST OF OTHER CHALLENGES IN 2020, MORE THAN 300 GLOCK OWNERS AND COMPETITORS FROM ACROSS THE COUNTRY SHOWED THEIR DEDICATION TO THE SHOOTING SPORTS THEY LOVE.

■ ARTICLE AND PHOTOS BY ANDRE' M. DALL'AU

The 2020 GLOCK Annual Shoot XXVII and Gunny Challenge XVI were held, as in the past, at the CMP Talladega Marksmanship Park. But this year's match was more than hundreds of shooters enjoying the GLOCK Sport Shooting Foundation's (GSSF's) challenging stages and Matchmeisters going head-to-head in the Gunny Challenge. It was also GLOCK's Veteran and Law Enforcement Appreciation Shoot in which GLOCK hosts veterans and law enforcement personnel for friendly competition. It is events like these that underscore the fact that there is no other firearm company in the world that gives back more to its customers or works to honor our defenders more than GLOCK.

VETERAN TOUGH

The 2020 gathering of veterans and law enforcement officers included retired Marine Gregory Juedes, Josh Rottkamp, a former Marine mortar-man and machine-gunner, and Cherokee County Sheriff's Office S.W.A.T. Captain John New. During his time in Afghanistan with the Marines, Juedes had an RPG impact on the top of his M240 machine gun while he was in the turret of a Humvee on patrol. The RPG's explosion miraculously did not kill him, thanks to the life-saving actions performed by another wounded corpsman. However, the blast cooked off all the ammo on Juedes' vest and destroyed the M240, his M27, and most of his right arm—and as he showed at Talladega, none of it dampened his spirit.

Juedes said, "I love being here. It is a great atmosphere, with tremendous people, and it's wonderful to get out of the office and shoot!" He called out GLOCK for what he sees as its outstanding support of both veterans and defenders. "There is no other company that does what GLOCK has done."

TREMENDOUS TURNOUT IN A TURBULENT YEAR

The GLOCK Annual Shoot is not only the biggest annual GLOCK match, it is, historically, the biggest shooting event in the U.S. As with all GSSF matches, each shooter competes only against similarly experienced and equipped GLOCK

competitors. There are nine divisions in the Amateur class and eight in the Master class. Even with the severe challenges America faced in 2020, the match was attended by a remarkable 321 competitors shooting 767 match entries.

Part of the Annual Shoot weekend is GLOCK's Annual Gunny Challenge, held in memory of R. Lee Erme, better known simply as "The Gunny." The Gunny Challenge is an invitation-only competition between GLOCK "Matchmeisters," the best of the best. When it was over, Brian Giovannini from Savannah, Georgia, was the overall Champion, remarkable in his first time entering the Challenge. An experienced federal law enforcement officer, he shot against 16 other Matchmeisters, including Butch Barton, a six-time winner of the Gunny Challenge, to claim the \$3,000 grand prize.

When asked about what he likes about GLOCKS, Giovannini said, "They are extremely accurate, easy to engage targets with rapidly, and their low bore axis makes it easy to keep on target with their low recoil. The magazine well, especially on the new Gen5 pistols, makes for quick reloading. I just won't shoot anything else!"

Danny Clifton, another first-time Gunny Challenge competitor, took second-place honors and a cash prize of \$2,000. Clifton has participated in shooting competitions for more than a quarter-century and just earned his Matchmeister rating in January 2020. For the second year in a row, the third-place finisher was Andrea Boone, taking home a \$1,000 check. Boone is the only female Matchmeister to place in the top four at the Gunny Challenge. Finally, taking fourth place and winning a GLOCK of his choice, was long-time GSSF competitor Bryan Wilhite.

Based on 2020's attendance and enthusiasm, the Gunny Challenge continues to be a favorite of GSSF shooters and spectators alike. Many are already planning to be back in 2021. Next year's GLOCK Annual Shoot XXVIII and Gunny Challenge XVII will take place September 17 to 19, 2021. For more information about GSSF and its matches, visit gssfonline.com. ☉



DESIGNED FOR MAKING MEMORIES

THE G44 .22 LR CALIBER PISTOL

The accuracy and fun you've come to expect from GLOCK, now in a small caliber pistol.

**Commit to perfection
with the G44.**

Hybrid steel-polymer slide.
Adjustable rear sights.
Load-assist magazine.



plink44.com

GSSF

Good. Solid. Shooting. Fun.

Ready for a little friendly competition out at the range?
Join the GLOCK Sport Shooting Foundation
to compete in a league and more!

For match schedules,
GSSF official rules
and other information,
visit gssfonline.com

